



Datasheet of LOCOSYS M.2 Card

GNSS M.2 Series

Vision 0.4

2024/9/24

LOCOSYS Technology Inc.

20F.-13, No.79, Sec. 1, Xintai 5th Rd.,

Xizhi District, New Taipei City 221, Taiwan

☎ 886-2-8698-3698

☎ 886-2-8698-3699

www.locosystech.com

Contents

1.	Introduction.....	3
2.	Features.....	3
3.	Application.....	3
4.	Product Features and Specifications of M.2 board	4
5.	Pin assignment and descriptions	5
6.	Part Numbers / Ordering Information.....	6
6.1	Product list of LOCOSYS M.2 series	6
6.2	The pin out for the I/O connector	7
6.3	Active Antenna Connector.....	8
6.4	Electrical Specification	8
7.	Detailed Feature Description	9
7.1	USB.....	9
7.2	TIMEPULSE.....	9
7.3	External Interrupt Input/WHEELTICK Input.....	9
7.4	FWD.....	9
7.5	On-Board Indicator LEDs.....	10
8.	Outline dimensions	10
9.	Accessory.....	11
9.1	External I/O Cable	11
9.2	IPEX to SMA Female Cable	11
10.	Packing information.....	12
11.	Document change list.....	13



1. Introduction

LOCOSYS M.2 series is a GNSS receiver based on the very small industry standard M.2 Type B form factor. Using the USB interface, the M.2 series provides global positioning and time-stamp information, while taking up little space and power within a system. Also considering the existing support for Windows and Linux, the M.2 series can easily integrate into any existing system, as well as easily implemented into new systems.

2. Features

- Multipath detection and suppression
- Works with passive and active antenna
- Alarm statuses detected by VMDS
- RoHS compliant (Lead-free)
- Integrated LOCOSYS 1612 series GNSS module

3. Application

- Automotive navigation
- Vehicle Remote Monitoring
- Router and IDC application
- IPC with GNSS Function.
- 5G AIoT & Smart Industry

4. Product Features and Specifications of M.2 board

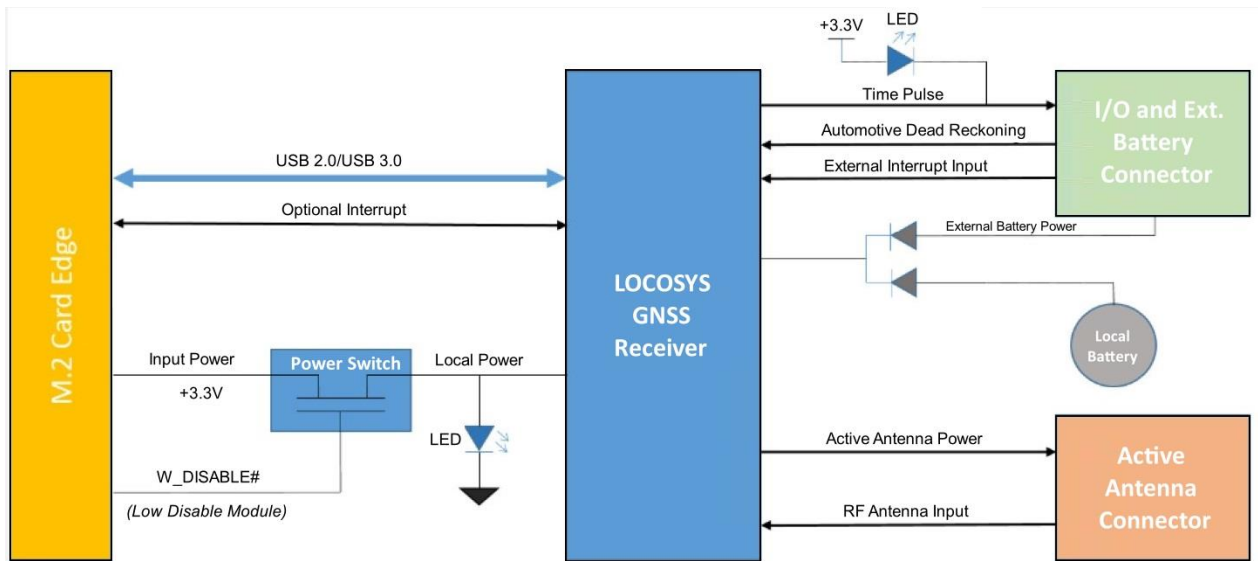

Figure 1. Block Diagram

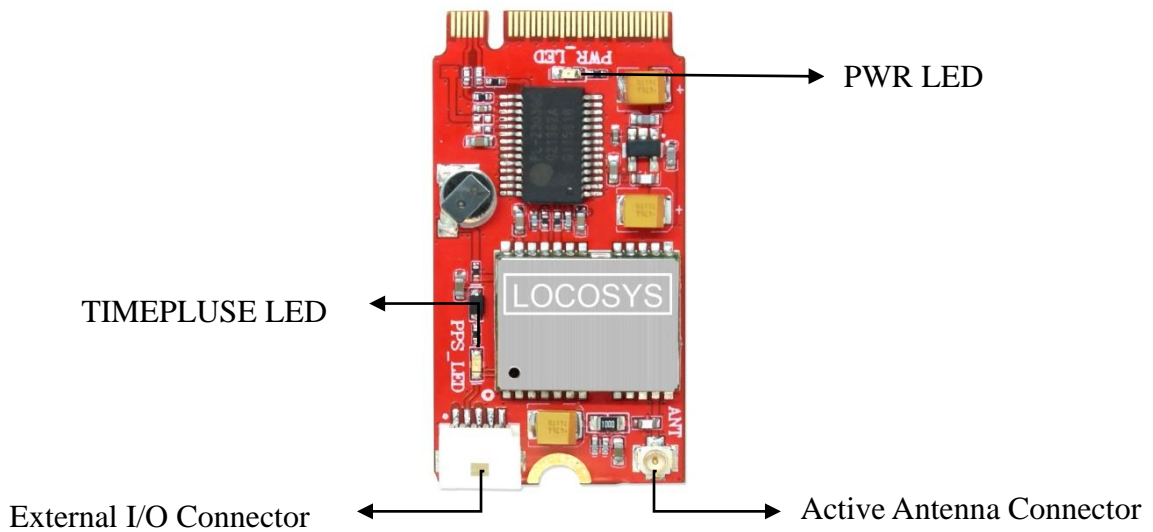

Figure 2. Connector Summary & Locations

5. Pin assignment and descriptions

The M.2 GPS pin-out is compliant to the M.2 Socket 2 with B Key. This module uses only +3.3V for input power and all I/O is +3.3V signaling.

Function	M.2 Card Edge Connector			
Location	P3			
Pin out	Signal	Pin	Pin	Signal
	NC	1	2	+3.3V
	GND	3	4	+3.3V
	GND	5	6	NC
	USB_D+	7	8	NC
	USB_D-	9	10	NC
	GND	11	12	Connector Key
	Connector Key	13	14	Connector Key
	Connector Key	15	16	Connector Key
	Connector Key	17	18	Connector Key
	Connector Key	19	20	NC
	NC	21	22	NC
	NC	23	24	NC
	NC	25	26	NC
	GND	27	28	NC
	NC	29	30	NC
	NC	31	32	NC
	GND	33	34	NC
	NC	35	36	NC
	NC	37	38	NC
	GND	39	40	NC
	NC	41	42	NC
	NC	43	44	NC
	GND	45	46	NC
	NC	47	48	NC

	NC	49	50	NC
	GND	51	52	NC
	NC	53	54	NC
	NC	55	56	NC
	GND	57	58	NC
	NC	59	60	NC
	NC	61	62	NC
	NC	63	64	NC
	NC	65	66	NC
	NC	67	68	NC
	NC	69	70	VCC
	GND	71	72	VCC
	GND	73	74	VCC
	NC	75		

Fig 5 Pin descriptions

6. Part Numbers / Ordering Information

6.1 Product list of LOCOSYS M.2 series

Part Number	
M.2-52Q	M.2 GNSS Receiver populated with MG-1612-52Q
M.2-V2b	M.2 GNSS Receiver populated with MC-1612-V2b
M.2-15R	M.2 GNSS Receiver populated with RTK-1612
M.2-35AD	M.2 GNSS Receiver populated with MG-1612AD-DR
M.2-R35AD	M.2 GNSS Receiver populated with RTK-1612AD-DR

<Note>

1. The performance of the GNSS function, please refer to our LOCOSYS website

6.2 The pin out for the I/O connector

Function	External I/O Connector		
Connector	Manufacturer: Molex		
Mating Connector	Manufacturer: Molex CTI Cable		
Pin out	Pin	Signal	Description
	①	EXT_INT/ WHEELTICK	External Interrupt Input or Speed pulse input
	②	TIMEPULSE	Time plus Output
	③	FWD	Forward/Reverse indicator
	④	GND	Digital Ground
	⑤	NC	

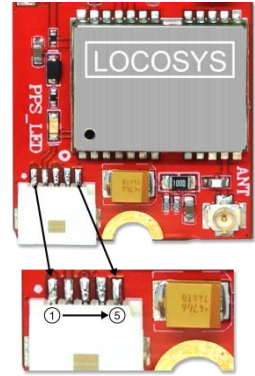

Table 6.2-1 Pin descriptions

6.3 Active Antenna Connector

Function	Active Antenna Connector
Connector	IPEX

Table 6.3 Active Antenna Connector



6.4 Electrical Specification

Parameter	Minimu (m)	Maximu(m)	Condition
Supply Voltage (VCC)	-0.5	3.6	Volt
Input Pin Voltage	-0.5	VCC+0.5	Volt
Input Power at RF_IN		Follow the Spec	dBm
Operation Temperature	-40	+85	°C
Storage Temperature	-40	+85	°C

Table 6.4-1 Maximum Ratings

Parameter	Min	Typ	Max	Unit
Supply Voltage (VCC)	3	3.3	3.6	Volt
Acquisition Current (exclude active antenna current)				mA
Tracking Current (exclude active antenna current)				mA

<Note>

1. Please follow the LOCOSYS GNSS module datasheet.

Table 6.4-2 Operating Conditions

7. Detailed Feature Description

(Please refer to LOCOSYS GNSS module datasheet)

7.1 USB

The M.2 GPS uses a USB 2.0 Full Speed (12Mb/s) interface as the primary communication bus. The USB interfaces connect between the GPS receiver and the M.2 card edge connector (pins 7/9).

7.2 TIMEPULSE

(Please refer to LOCOSYS GNSS module datasheet)

The TIMEPULSE output is a buffered and ESD protected signal from the GNSS receiver. This signal connects to pin 2 of the External I/O Connector. It also drives the TIMEPULSE LED. By default, when satellites are not fixed this signal is High. When satellites are fixed, this signal pulses at 1 pulse- per-second (1Hz) with 100ms.

7.3 External Interrupt Input/WHEELTICK Input

(Please refer to LOCOSYS GNSS module datasheet)

The external interrupt/WHEELTICK input is an ESD protected input signal from the external I/O connector to the GPS receiver. On modules that do not support Automotive Dead Reckoning, this signal will always be an External Interrupt input, and this input can use for control of the GPS receiver or for aiding. Setting method please refer to our module datasheet.

7.4 FWD

(Please refer to LOCOSYS GNSS Module Datasheet)

The forward/reverse signal is an ESD protected input used on modules that support Automotive Dead Reckoning. This signal is using to indicate the moving direction of the module. An active high indicates moving forward and a low for moving backwards.

7.5 On-Board Indicator LEDs

LED	Description
TIMEPULSE	TIMEPULSE visualizing indicator. This LED will blink at the rate and duty cycle of the TIMEPULSE output.
PWR	ON: indicates the module is powered on and enabled OFF: indicated the module is not powered and is disabled *the module is enabled/disabled using the W_DISABLE1# input from the M.2 card edge connector

8. Outline dimensions

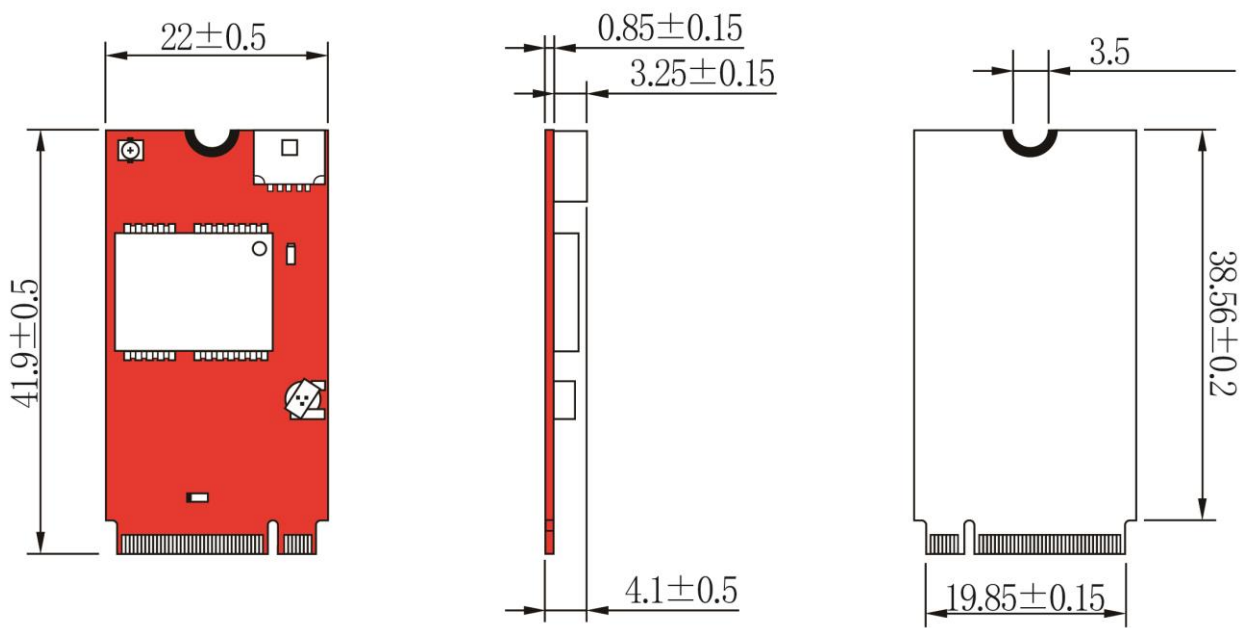
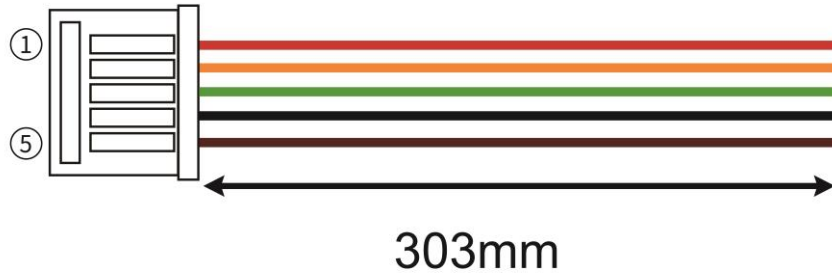

Figure 3

Symbol	Min. (mm)	Typ. (mm)	Max. (mm)
W	21.5	22	22.5
L	41.4	41.9	42.4
H	4.05	4.1	4.15

9. Accessory

9.1 External I/O Cable



	Signal	Open End (Unterminated)
1 (RED)	See I/O Connector Section for pin-out	Un-terminated
2 (ORANGE)		Un-terminated
3 (GREEN)		Un-terminated
4 (BLACK)		Un-terminated
5 (BROWN)		Un-terminated

9.2 IPEX to SMA Female Cable



IPEX	TO	SMA Female (Socket)
------	----	---------------------

10. Packing information



1pcs in an antistatic bag

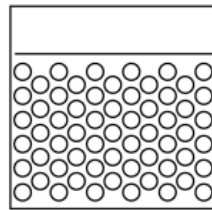

6pcs in a bubble bag

30 bubble bags in a carton
(180pcs)

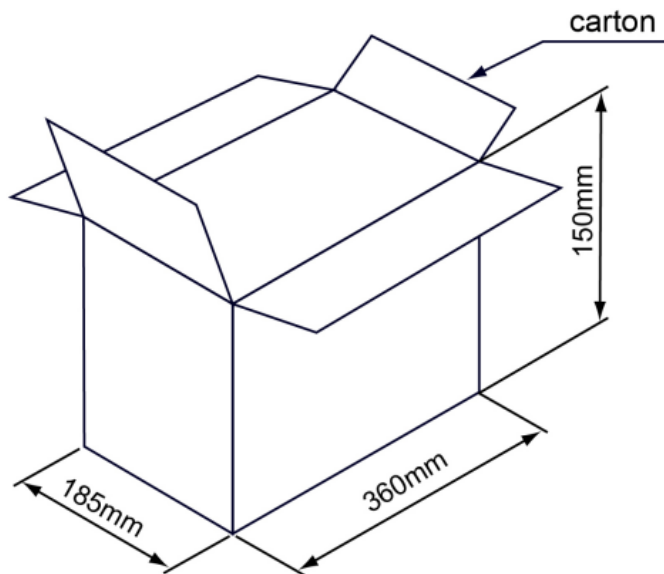

Tolerance: ± 10 mm

11. Document change list

Revision 0.1

- Draft release on Mar. 14th. 2023.

Revision 0.2 (August 1, 2023)

- Revised the active antenna connector in section 6.3.
- Revised the IPEX to SMA Female Cable in section 9.2.

Revision 0.3 (November 20, 2023)

- Revised part number M.2-35AD information.

Revision 0.4 (September 24, 2024)

- Added part number M.2-52Q.
- Removed part number M.2-STi-DG 、 M.2-STi-GT.