

Product name	Description	Version
LS2003J-2RE	Standalone GPS smart antenna module	1.1



1 Introduction

LS2003J-2RE is a complete standalone GPS smart antenna module, the module is powered by MediaTek GPS chip and it can provide user with superior sensitivity and performance even in urban canyon and dense foliage environment.

The module includes embedded chip antenna and GPS receiver circuits, dedicated designed for tablet PC, MID, PND and smart phone that are going to integrate GPS function.

2 Features

- Tiny size: 16.0x12.2x2.8 mm
- MediaTek high sensitivity solution
- Support 66-channel GPS
- Fast TTFF at low signal level
- Built-in 12 multi-tone active interference canceller
- Support Japan QZSS
- Ultra low power consumption
- Fast TTFF at low signal level
- ± 1 ns high accuracy time pulse (PPS)
- Indoor and outdoor multi-path detection and compensation
- SMD type with stamp holes; RoHS compliant
- IATF 16949 quality control
- Support RTCM SC-104 Version-2.x

3 Application

- Personal positioning and navigation
- Automotive navigation, model aircraft navigation
- Marine navigation

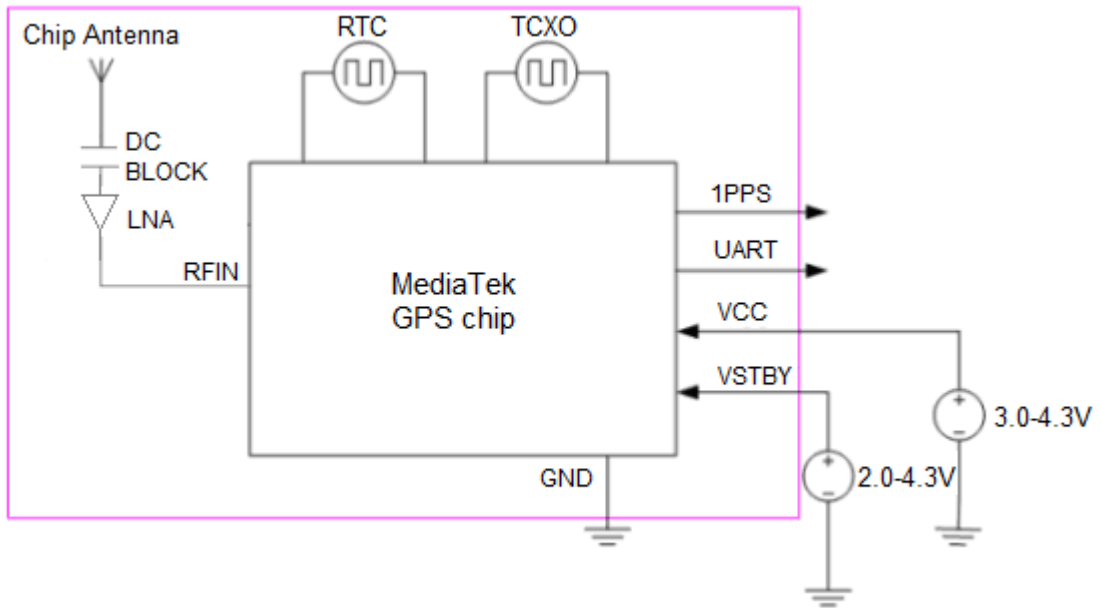

Fig 3-1 System block diagram.

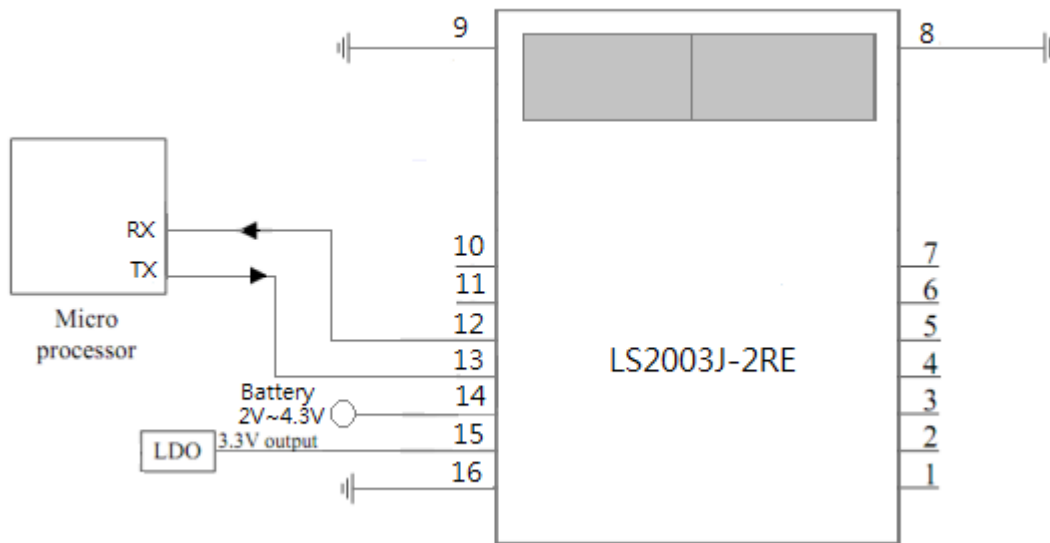

Fig 3-2 Typical application circuit that uses embedded antenna.

4 GNSS receiver

4.1 GPS receiver

Chip	MediaTek MT3337E	
Frequency	L1 1575.42MHz, C/A code	
Channels	Support 66 channels (22 Tracking, 66 Acquisition)	
Update rate	1Hz default	
Acquisition Time	Hot start (Open Sky)	1s (typical)
	Cold Start (Open Sky)	34s (typical)
Position Accuracy	Autonomous	3m (2D RMS)
	SBAS	2.5m (depends on accuracy of correction data).
Max. Altitude	50,000m	
Max. Velocity	< 515 m/s	
Protocol Support	NMEA 0183 ver 3.10	9600 bps, 8 data bits, no parity, 1 stop bits (default) 1Hz: GGA , GLL , GSA , GSV , RMC , VTG
	RTCM SC-104 v2.x	message types 1,2,3, and 9

4.2 GPS antenna

The antenna type of LS2003J-2RE is chip antenna. Its performance is greatly affected by many factors, such as the size of PCB ground plane, installation position and its surrounding materials. In order to make it perform well and save user from reinventing the wheel, please consult our FAE before get started to design.

Antenna type	Chip antenna
Polarization	RHCP
Frequency	1575.42MHz

5 Pin assignment and descriptions

Top View

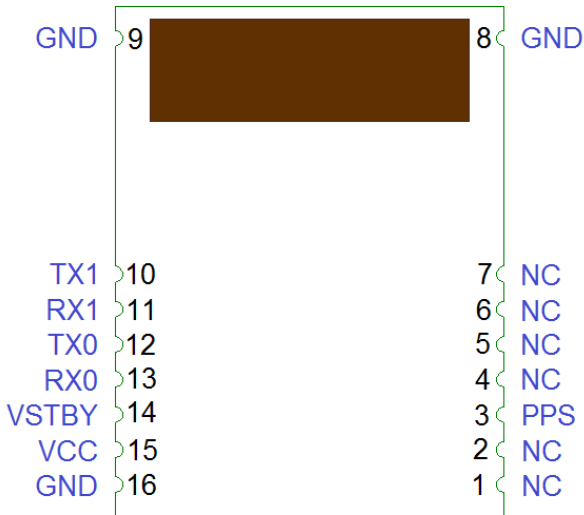

Table 5-1 Pin descriptions

Pin #	Name	Type	Description	Note
1	NC		No connect	
2	NC		No connect	
3	PPS	O	Time pulse (PPS, default 100 ms pulse/sec when 3D fix is available)	
4	NC		No connect	
5	NC		No connect	
6	NC		No connect	
7	NC		No connect	
8	GND	P	Ground	
9	GND	P	Ground	
10	TX1	O	Serial output for channel 1	
11	RX1	I	Serial input for channel 1	
12	TX0	O	Serial output for channel 0 (Default NMEA)	
13	RX0	I	Serial input for channel 0 (Default NMEA)	
14	VSTBY	P	Backup battery supply voltage This pin is optional.	1
15	VCC	P	DC supply voltage	
16	GND	P	Ground	

<Note>

1. The module doesn't has hot start when this pin and VCC pin are not applied.

6 DC & Temperature characteristics

6.1 Absolute maximum ratings

Parameter	Symbol	Ratings	Units
Input Voltage	VCC	4.3	V
Input Backup Battery Voltage	VSTBY	4.3	V
Operating Temperature Range	Topr	-40 ~ 85	°C
Storage Temperature Range	Tstg	-40 ~ 85	°C

6.2 DC Electrical characteristics

Parameter	Symbol	Conditions	Min.	Typ.	Max.	Units
Input Voltage	VCC		3.0	3.3	4.3	V
Input Backup Battery Voltage	VSTBY		2.0		4.3	V
Supply Current	Icc	VCC = 3.3V, w/o active antenna, Peak Tracking Acquisition Standby		23 ⁽¹⁾	90	mA
				26		mA
				441		uA
Backup Battery Current	IVSTBY	VCC = 0V		9		uA
High Level Input Voltage	V _{IH}		2.0		3.6	V
Low Level Input Voltage	V _{IL}		-0.3		0.8	V
High Level Input Current	I _{IH}	no pull-up or down	-1		1	uA
Low Level Input Current	I _{IL}	no pull-up or down	-1		1	uA
High Level Output Voltage	V _{OH}		2.4		3.3	V
Low Level Output Voltage	V _{OL}				0.4	V
High Level Output Current	I _{OH}			2		mA
Low Level Output Current	I _{OL}			2		mA

Note 1: Measured when position fix (1Hz) is available, input voltage is 3.3V.

6.3 Temperature characteristics

Parameter	Symbol	Min.	Typ.	Max.	Units
Operating Temperature	Topr	-40	-	85	°C
Storage Temperature	Tstg	-40	25	85	°C

7 Mechanical specification
 7.1 Outline dimensions

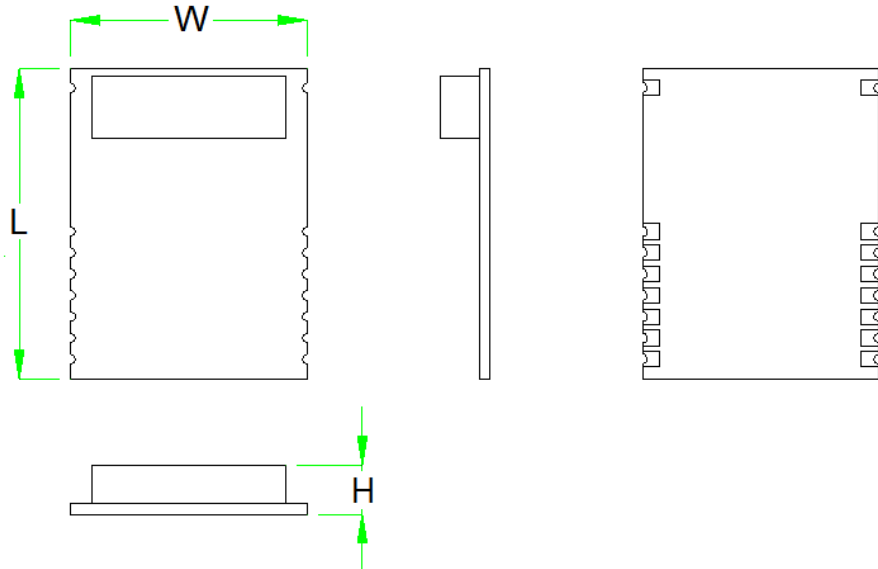

Symbol	Min. (mm)	Typ. (mm)	Max. (mm)
W	12.1	12.2	12.3
L	15.9	16.0	16.6
H	2.7	2.8	2.9

7.2 Recommended land pattern dimensions

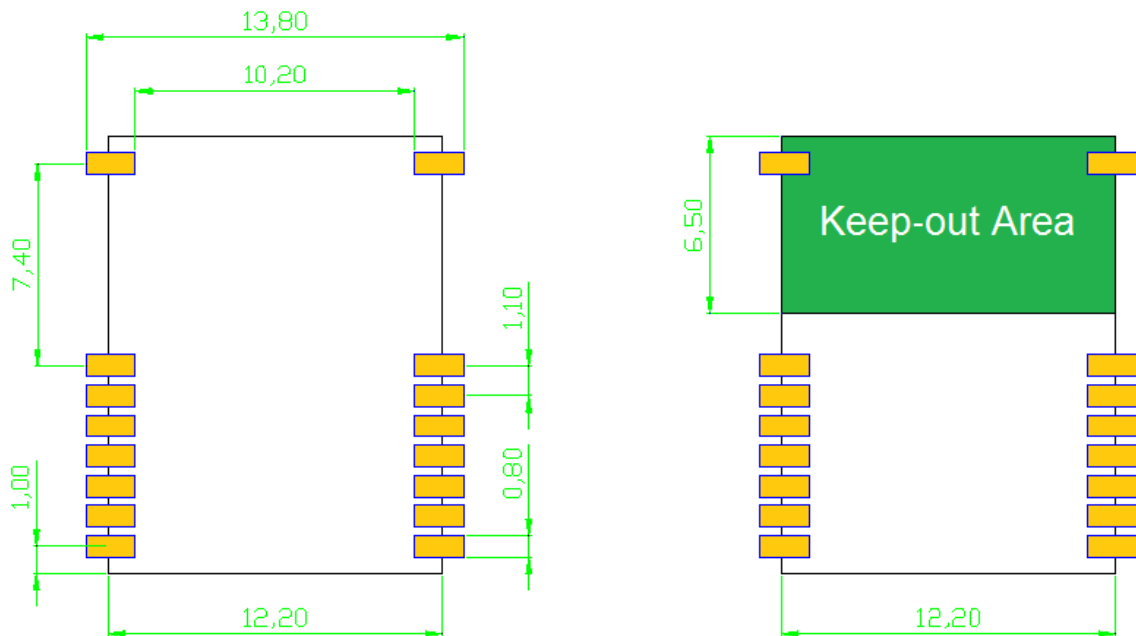

Unit: mm

7.3 PCB layout suggestion

The LS2003J-2RE module antenna's radiation pattern and tuning are directly related to the size and shape of the ground plane. When user integrates this module into product, more than likely it will be on a different size PCB. Which means the GPS performance will differ from the datasheet.

7.3.1 Limitation of PCB width

Suggest the PCB width should be equal to or greater than 50mm, if the PCB width is smaller than 50mm that will cause poor GPS performance. For the optimum GPS performance, the PCB width larger than or equal to 80mm is suggested.

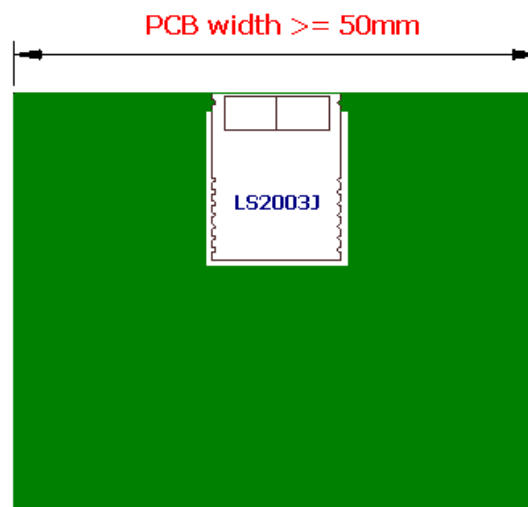

Note: All copper under the module keep-out area (6.5x12.2mm) should be removed. Placement of other components is not allowed under the keep-out area on opposite side.

7.3.2 Installation position on the PCB

The optimum PCB placement of LS2003J-2RE module is at the center of the top edge.

But LS2003J-2RE can receive GPS signals from many directions so that it can be placed on the bottom side or top side.

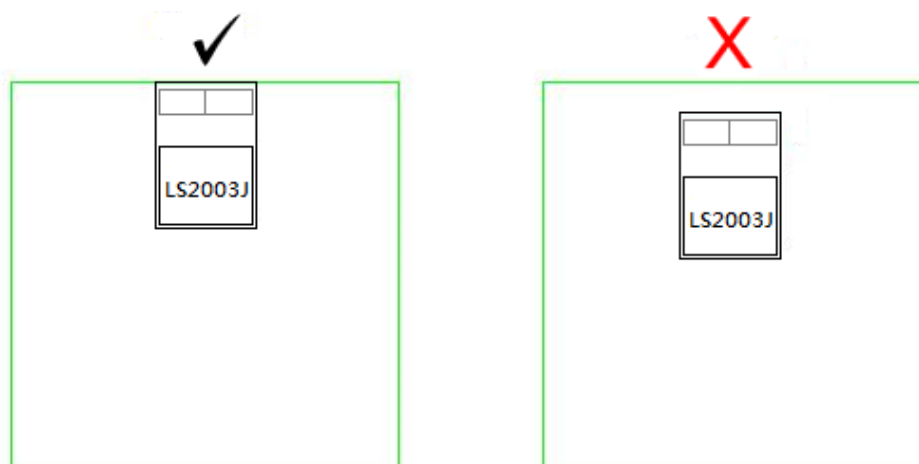

Note: Any metal materials surround the LS2003J-2RE module will degrade GPS performance.

LS2003J can be placed on the bottom side or top side.

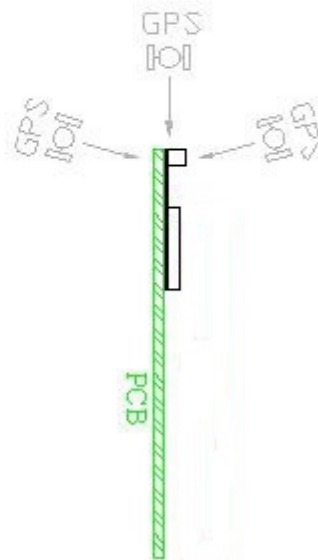
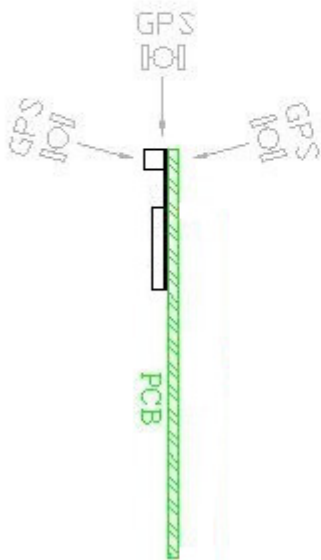
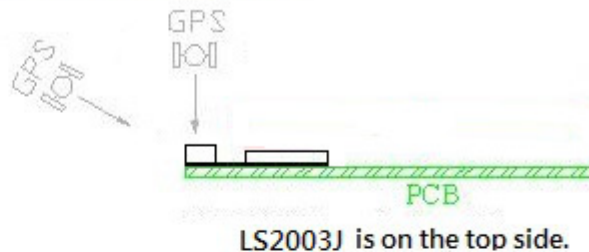
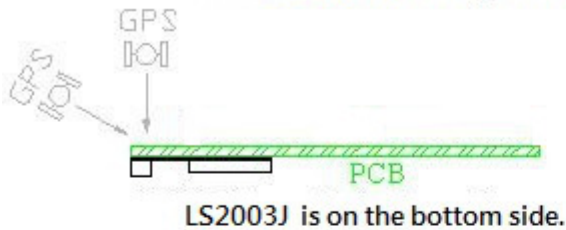

8 Software interface

8.3 NMEA output message

Table 8.1-1 NMEA output message

NMEA record	Description
GGA	Global positioning system fixed data
GLL	Geographic position - latitude/longitude
GSA	GNSS DOP and active satellites
GSV	GNSS satellites in view
RMC	Recommended minimum specific GNSS data
VTG	Course over ground and ground speed

● GGA--- Global Positioning System Fixed Data

Table 8.1-2 contains the values for the following example:

\$GPGGA,053740.000,2503.6319,N,12136.0099,E,1,08,1.1,63.8,M,15.2,M,*,*64

Table 8.1-2 GGA Data Format

Name	Example	Units	Description
Message ID	\$GPGGA		GGA protocol header (GPGGA)
UTC Time	053740.000		hhmmss.sss
Latitude	2503.6319		ddmm.mmmm
N/S indicator	N		N=north or S=south
Longitude	12136.0099		dddmm.mmmm
E/W Indicator	E		E=east or W=west
Position Fix Indicator	1		See Table 8.1-3 (2: DGPS(RTCM) or SBAS)
Satellites Used	08		Range 0 to 33
HDOP	1.1		Horizontal Dilution of Precision
MSL Altitude	63.8	meters	
Units	M	meters	
Geoid Separation	15.2	meters	
Units	M	meters	
Age of Diff. Corr.		second	Null fields when DGPS is not used
Diff. Ref. Station ID			
Checksum	*64		
<CR> <LF>			End of message termination

Table 8.1-3 Position Fix Indicators

Value	Description
0	Fix not available or invalid
1	GPS SPS Mode, fix valid

2	Differential GPS, SPS Mode, fix valid
3-5	Not supported
6	Dead Reckoning Mode, fix valid

● GLL--- Geographic Position – Latitude/Longitude

Table 8.1-4 contains the values for the following example:

\$GPGLL,2503.6319,N,12136.0099,E,053740.000,A,A*52

Table 8.1-4 GLL Data Format

Name	Example	Units	Description
Message ID	\$GPGLL		GLL protocol header
Latitude	2503.6319		ddmm.mmmm
N/S indicator	N		N=north or S=south
Longitude	12136.0099		dddmm.mmmm
E/W indicator	E		E=east or W=west
UTC Time	053740.000		hhmmss.sss
Status	A		A=data valid or V=data not valid
Mode	A		A=autonomous, D=DGPS, E=DR, N=Data not valid, R=Coarse Position, S=Simulator
Checksum	*52		
<CR> <LF>			End of message termination

● GSA---GNSS DOP and Active Satellites

Table 8.1-5 contains the values for the following example:

\$GPGSA,A,3,24,07,17,11,28,08,20,04,,,,,2.0,1.1,1.7*35

Table 8.1-5 GSA Data Format

Name	Example	Units	Description
Message ID	\$GPGSA		GSA protocol header
Mode 1	A		See Table 8.1-6
Mode 2	3		See Table 8.1-7
ID of satellite used	24		Sv on Channel 1
ID of satellite used	07		Sv on Channel 2
....		
ID of satellite used			Sv on Channel 12
PDOP	2.0		Position Dilution of Precision
HDOP	1.1		Horizontal Dilution of Precision
VDOP	1.7		Vertical Dilution of Precision
Checksum	*35		

<CR> <LF>		End of message termination
-----------	--	----------------------------

Table 8.1-6 Mode 1

Value	Description
M	Manual- forced to operate in 2D or 3D mode
A	Automatic-allowed to automatically switch 2D/3D

Table 8.1-7 Mode 2

Value	Description
1	Fix not available
2	2D
3	3D

● GSV---GPS Satellites in View

Table 8.1-8 contains the values for the following example:

*\$GPGSV,3,1,12,28,81,285,42,24,67,302,46,31,54,354,,20,51,077,46*73*

*\$GPGSV,3,2,12,17,41,328,45,07,32,315,45,04,31,250,40,11,25,046,41*75*

*\$GPGSV,3,3,12,08,22,214,38,27,08,190,16,19,05,092,33,23,04,127,*7B*

Table 8.1-8 GSV Data Format

Name	Example	Units	Description
Message ID	\$GPGSV		GSV protocol header
Total number of messages ¹	3		Range 1 to 4
Message number ¹	1		Range 1 to 4
Satellites in view	12		
Satellite ID ²	28		Channel 1 (Range 01 to 196)
Elevation	81	degrees	Channel 1 (Range 00 to 90)
Azimuth	285	degrees	Channel 1 (Range 000 to 359)
SNR (C/No)	42	dB-Hz	Channel 1 (Range 00 to 99, null when not tracking)
....		
Satellite ID	20		Channel 4 (Range 01 to 196)
Elevation	51	degrees	Channel 4 (Range 00 to 90)
Azimuth	077	degrees	Channel 4 (Range 000 to 359)
SNR (C/No)	46	dB-Hz	Channel 4 (Range 00 to 99, null when not tracking)
Checksum	*73		
<CR> <LF>			End of message termination

<Note>

1. Depending on the number of satellites tracked multiple messages of GSV data may be required.

● RMC---Recommended Minimum Specific GPS Data

Table 8.1-9 contains the values for the following example:

```
$GPRMC,053740.000,A,2503.6319,N,12136.0099,E,2.69,79.65,100106,,A*53
```

Table 8.1-9 RMC Data Format

Name	Example	Units	Description
Message ID	\$GPRMC		RMC protocol header
UTC Time	053740.000		hhmmss.sss
Status	A		A=data valid or V=data not valid
Latitude	2503.6319		ddmm.mmmm
N/S Indicator	N		N=north or S=south
Longitude	12136.0099		dddmm.mmmm
E/W Indicator	E		E=east or W=west
Speed over ground	2.69	knots	True
Course over ground	79.65	degrees	
Date	100106		ddmmyy
Magnetic variation		degrees	
Variation sense			E=east or W=west (Not shown)
Mode	A		A=autonomous, D=DGPS, E=DR, N=Data not valid, R=Coarse Position, S=Simulator
Checksum	*53		
<CR> <LF>			End of message termination

● VTG---Course Over Ground and Ground Speed

Table 8.1-10 contains the values for the following example:

```
$GPVTG,79.65,T,,M,2.69,N,5.0,K,A*38
```

Table 8.1-10 VTG Data Format

Name	Example	Units	Description
Message ID	\$GPVTG		VTG protocol header
Course over ground	79.65	degrees	Measured heading
Reference	T		True
Course over ground		degrees	Measured heading
Reference	M		Magnetic
Speed over ground	2.69	knots	Measured speed
Units	N		Knots
Speed over ground	5.0	km/hr	Measured speed
Units	K		Kilometer per hour
Mode	A		A=autonomous, D=DGPS, E=DR, N=Data not valid,

			R=Coarse Position, S=Simulator
Checksum	*38		
<CR> <LF>			End of message termination

8.4 Proprietary NMEA input/output message

Please refer to MTK proprietary message.

8.5 Examples to configure the power mode of GPS module

The GPS module only supports standby mode, user can issue software command to make GPS module go into standby mode that consumes less than 200uA current. GPS module will be waked when receiving any byte. The following flow chart is an example to make GPS module go into standby mode and then wake up.

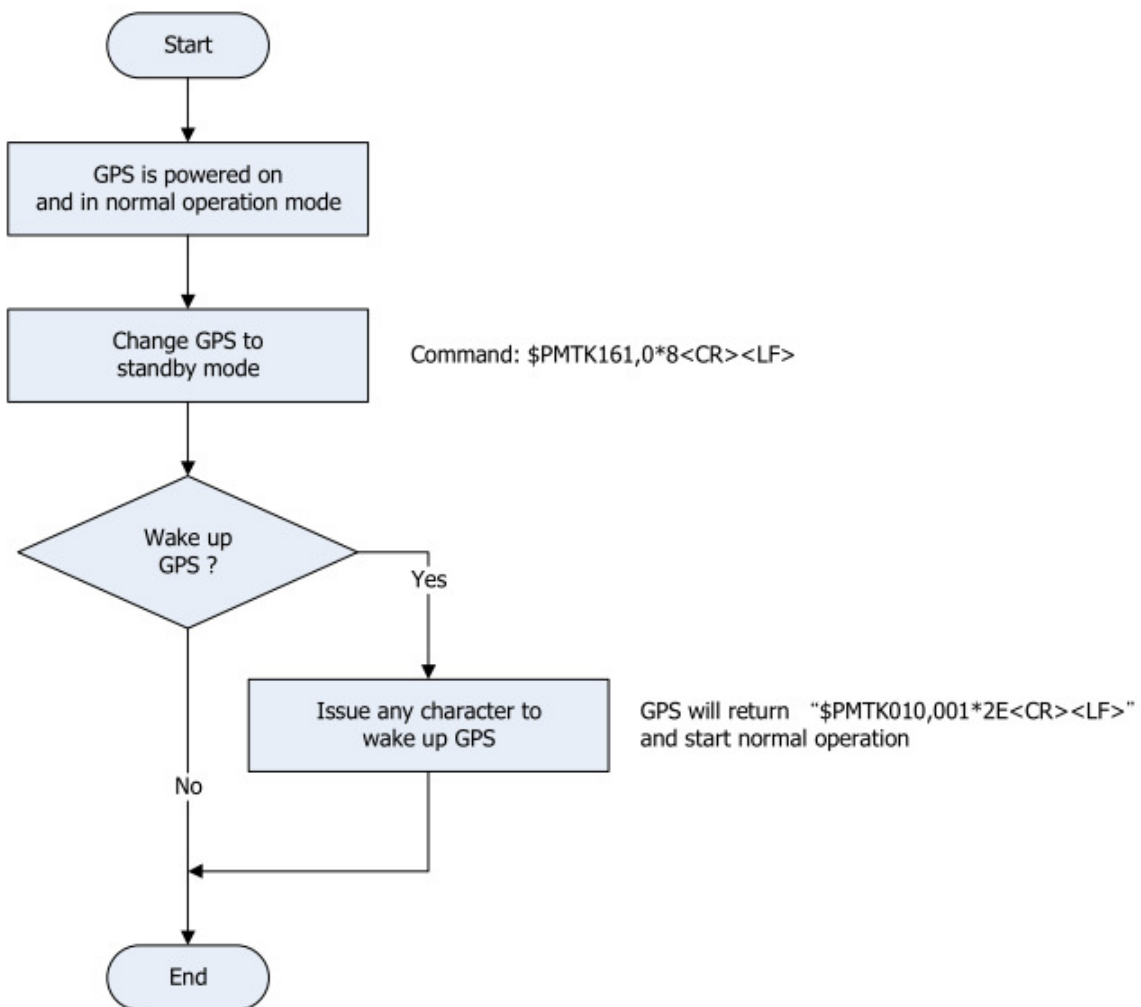

8.6 Examples to configure the update rate of GNSS module

The GNSS module supports up to 10Hz update rate that user can configure by issuing software commands. Note that the configurations by software commands are stored in the battery-backed SRAM that is powered through VBACKUP pin. Once it drains out, the default/factory settings will be applied.

Due to the transmitting capacity per second of the current baud rate, GPS module has to be changed to higher baud rate for high update rate of position fix. The user can use the following software commands to change baud rate.

Baud rate	Software command
Factory default	\$PMTK251,0*28<CR><LF>
4800	\$PMTK251,4800*14<CR><LF>
9600	\$PMTK251,9600*17<CR><LF>
19200	\$PMTK251,19200*22<CR><LF>
38400	\$PMTK251,38400*27<CR><LF>
57600	\$PMTK251,57600*2C<CR><LF>
115200	\$PMTK251,115200*1F<CR><LF>

Note: <CR> means Carriage Return, i.e. 0x0D in hexadecimal. <LF> means Line Feed, i.e. 0x0A in hexadecimal.

If the user does not want to change baud rate, it can be reduced the output NMEA sentences by the following software commands.

NMEA sentence	Software command
Factory default	\$PMTK314,-1*04<CR><LF>
Only GLL at 1Hz	\$PMTK314,1,0,0,0,0,0,0,0,0,0,0,0,0,0,0*29<CR><LF>
Only RMC at 1Hz	\$PMTK314,0,1,0,0,0,0,0,0,0,0,0,0,0,0,0*29<CR><LF>
Only VTG at 1Hz	\$PMTK314,0,0,1,0,0,0,0,0,0,0,0,0,0,0,0*29<CR><LF>
Only GGA at 1Hz	\$PMTK314,0,0,0,1,0,0,0,0,0,0,0,0,0,0,0*29<CR><LF>
Only GSA at 1Hz	\$PMTK314,0,0,0,0,1,0,0,0,0,0,0,0,0,0,0*29<CR><LF>
Only GSV at 1Hz	\$PMTK314,0,0,0,0,0,1,0,0,0,0,0,0,0,0,0*29<CR><LF>
Only ZDA at 1Hz	\$PMTK314,0,0,0,0,0,0,0,0,0,0,0,0,0,0,1*29<CR><LF>
RMC, GGA, GSA at 1Hz and GSV at 0.2Hz	\$PMTK314,0,1,0,1,1,5,0,0,0,0,0,0,0,0,0*2C<CR><LF>
If the command is correct and executed, GPS module will output message \$PMTK001,314,3*36<CR><LF>	

After the GPS module is changed to higher baud rate or reduced NMEA sentence, the user can configure it to high update rate of position fix by the following commands.

Interval of position fix	Software command
Every 100ms (10Hz) ⁽¹⁾	\$PMTK220,100*2F<CR><LF>
Every 200ms (5Hz)	\$PMTK220,200*2C<CR><LF>
Every 500ms (2Hz)	\$PMTK220,500*2B<CR><LF>
Every 1000ms (1Hz)	\$PMTK220,1000*1F<CR><LF>
Every 2000ms (0.5Hz) ⁽²⁾	\$PMTK220,2000*1C<CR><LF>
If the command is correct and executed, GNSS module will output message \$PMTK001,220,3*30<CR><LF>	

Note 1: The minimum interval of position fix is 100ms, i.e. the maximum update rate is 10Hz.

Note 2: The current consumption is the same with the update rate of 1Hz.

8.7 Configure the static navigation parameter

The output position of GPS module will keep the same and output speed will be zero if the actual speed is below the threshold of the static navigation parameter. This is useful for different applications. For example, the car stopped at a red light will get stationary GPS position if the threshold is 1.5m/s. It is better to disable this function by setting threshold to 0 for pedestrian navigation.

The format of the software command is as below.

\$PMTK386,speed threshold*checksum<CR><LF>

The unit of speed threshold is meter per second. The range of speed threshold is from 0.1m/s to 2.0m/s. Value 0 is to disable the function.

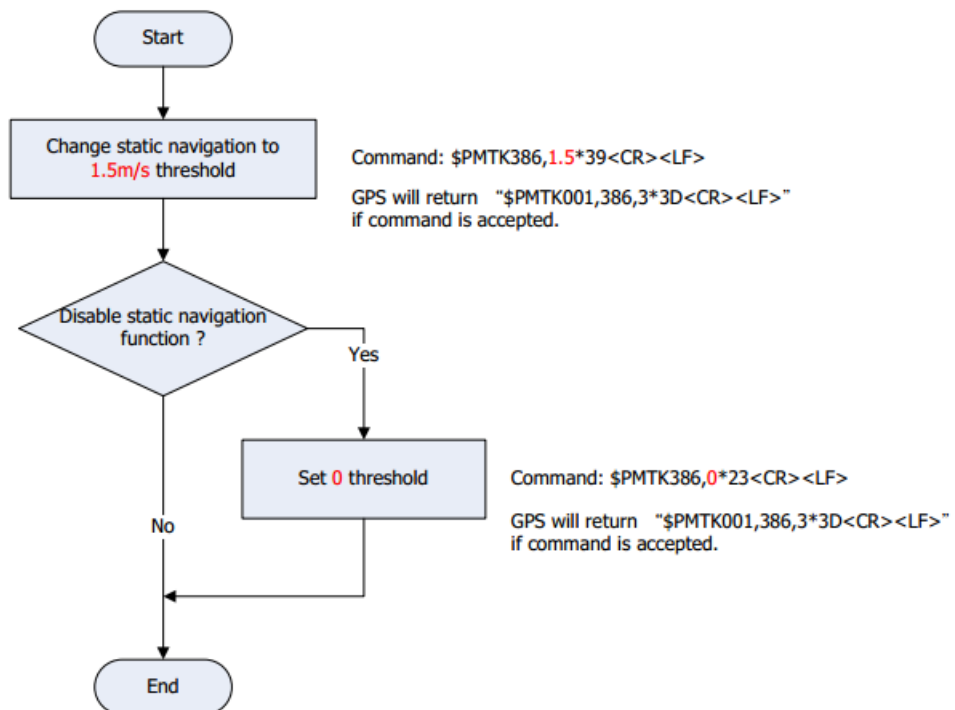

9 Recommended Soldering Temperature Profile

The module belongs to RoHS compliant. The maximum of peak temperature, real on top of PCB, is not over 240 Celsius.

Lead-free Processes

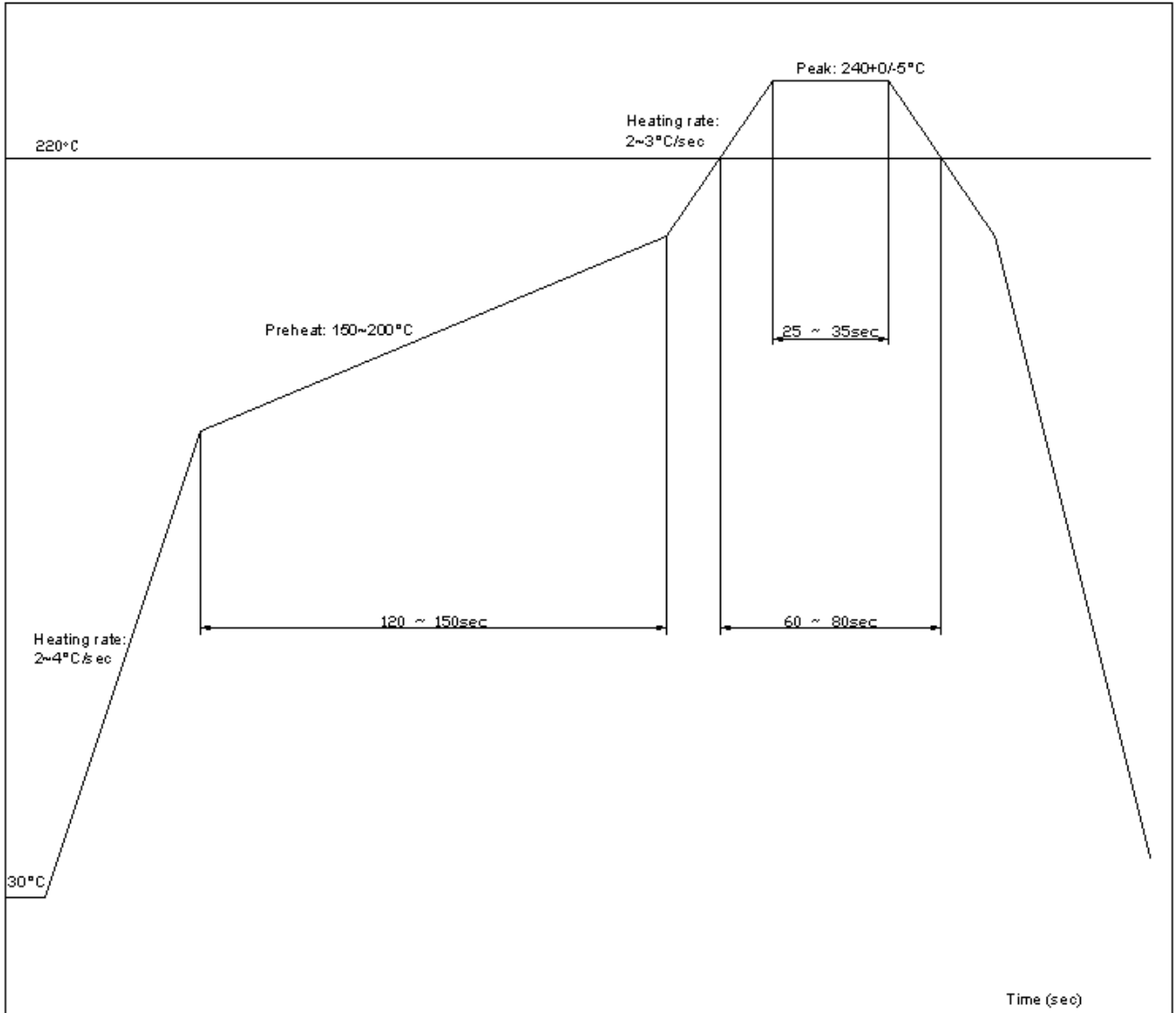

Lead-Free Solder Paste (Sn 96.5-Ag 3.0-Cu 0.5)

Cycle Interval: 300 sec

Note:

The LS2003J-2RE module should be soldered on the topside in the soldering process to prevent from falling down.

10 Reel Packing information

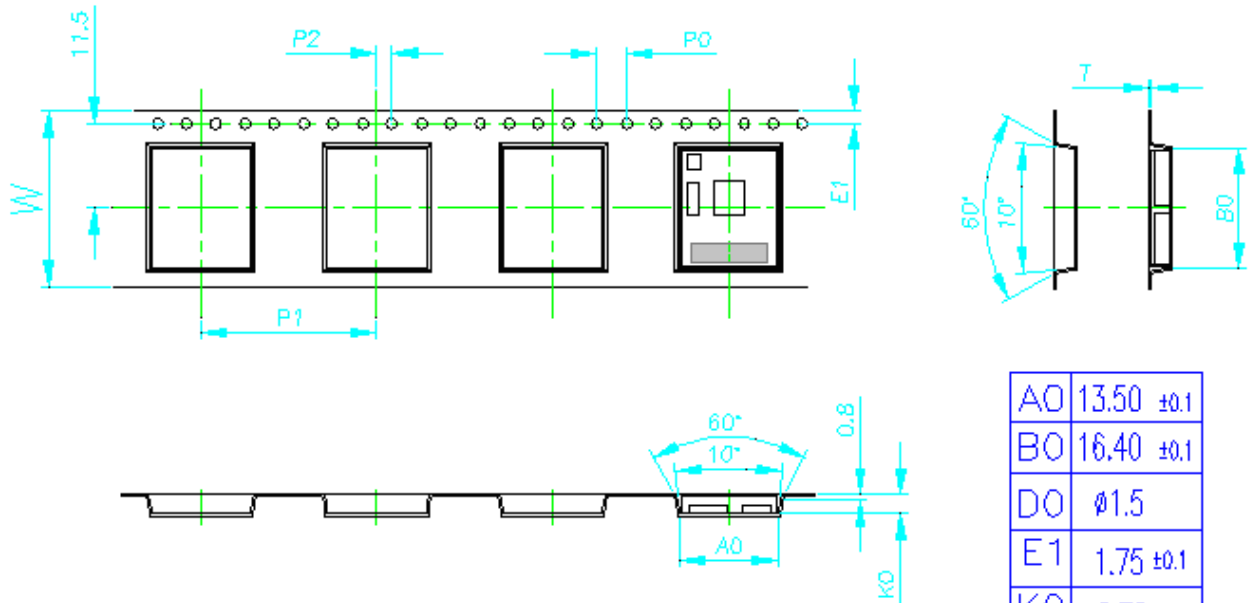

A0	13.50 ±0.1
B0	16.40 ±0.1
D0	∅1.5
E1	1.75 ±0.1
K0	2.70 ±0.1
P0	4.0 ±0.1
P1	24.00 ±0.1
P2	2.0 ±0.10
T	0.3 ±0.10
W	24.0 ±0.30

1. 10 sprocket hole pitch cumulative tolerance ± 0.2
2. Camber not to exceed 1mm in 100mm
3. A0 and B0 measured on a plane 0.3mm above the bottom of the pocket
4. K0 measured from a plane on the inside bottom of the pocket to the top surface of the carrier .
5. pocket position relative to sprocket hole measured as true position of pocket,not pocket hole.
6. Component load per 13"reel: 1000 pcs

11 Packing and Handling

GNSS modules, like any other SMD devices, are sensitive to moisture, electrostatic discharge, and temperature. By following the description sketched in the document for LOCOSYS GNSS module storage and handling, it is possible to reduce the chances of them being damaged during production.

11.1 Packing

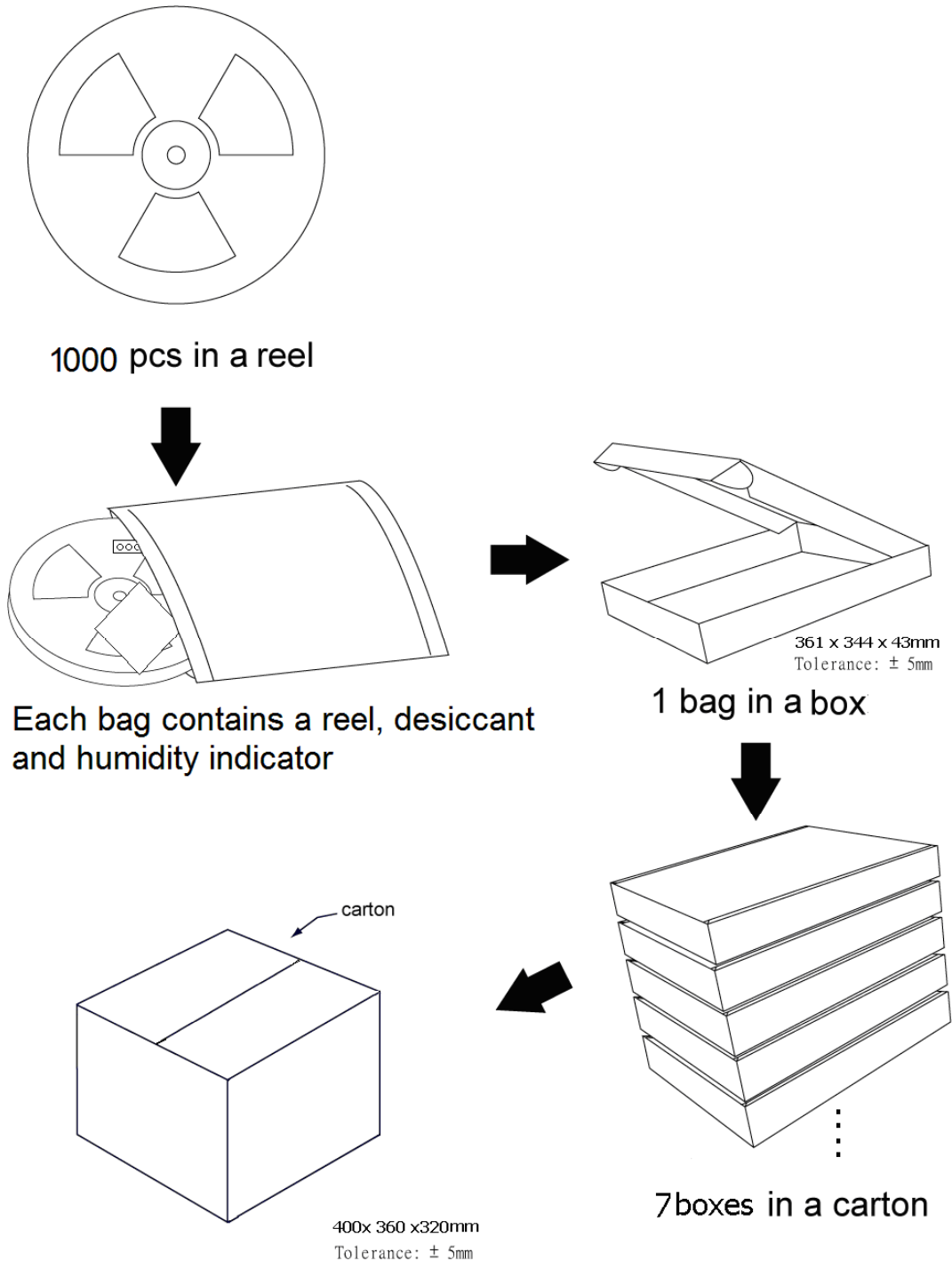

11.2 Moisture Sensitivity

The module belongs to moisture sensitive device (IPC/JEDEC J-STD-020C Level III). If it is not used by then, we strong recommended storing the GNSS modules in dry places such as dry cabinet. The approximate shelf life for LOCOSYS GNSS modules packages is 6 months from the bag seal date, when store in a non-condensing storage environment (<30°C/60% RH)

11.3 ESD Handling



Please carefully follow the following precautions to prevent severe damage to

GNSS modules.

LOCOSYS GNSS modules are sensitive to electrostatic discharges, and thus are Electrostatic Sensitive Devices (ESD). Careful handling of the GNSS modules and in particular RFIN pin must follow the standard ESD safety protections:

- Unless there is a galvanic coupling between the local GND and the PCB GND, then the first point of contact when handling the PCB shall always be between the local GND and PCB GND.
- Before working with RFIN pin, please make sure the GND is connected
- When working with RFIN pin, do not contact any charges capacitors or materials that can easily develop or store charges such as patch antenna, coax cable, soldering iron.
- When soldering RFIN pin, please make sure to use an ESD safe soldering iron (tip).

Document change list

Revision 1.0

- First release on December 1, 2017.

Revision 1.1 (Oct.16.2018)

- Modify Outline dimensions on page 1, 6.