

Product name	Description	Version
LS2003C	Standalone GPS smart antenna module	1.4

Datasheet of standalone GPS smart antenna module, LS2003C

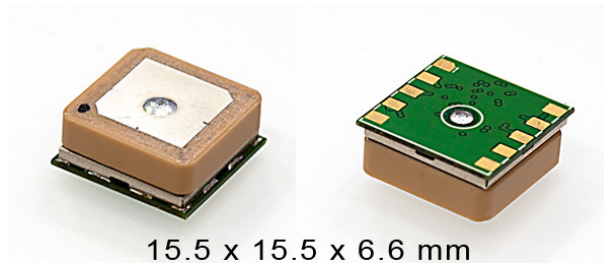

1 Introduction

LS2003C is a complete standalone GPS smart antenna module, including embedded patch antenna and GPS receiver circuits. The module is powered by MediaTek GPS chip and can acquire a lot of satellites at a time while providing fast time-to-first-fix and low power consumption. Besides, it can provide you with superior sensitivity and performance even in urban canyon and dense foliage environment.

This module supports hybrid ephemeris prediction to achieve faster cold start. One is self-generated ephemeris prediction (called EASY) that is no need of both network assistance and host CPU's intervention. This is valid for up to 3 days and updates automatically from time to time when GPS module is powered on and satellites are available. The other is server-generated ephemeris prediction (called EPO) that gets from an internet server. This is valid for up to 14 days. Both ephemeris predictions are stored in the on-board flash memory and perform a cold start time less than 15 seconds.

It is easy to install without both RF connector and coaxial cable that are needed in a separated GPS active antenna. In other words, reduce the cost and size. Also, speed up the time to market by eliminating R&D efforts on RF matching and stability between separated GPS antenna and module. Furthermore, it can be directly powered by a lithium battery without any external voltage regulators. Therefore, LS2003C of miniature size and brilliant performance is the best choice to be integrated into your slim devices.

2 Features

- Easy to install (SMT process capable)
- MediaTek high sensitivity solution
- Support 66-channel GPS
- Ultra low power consumption
- Fast TTFF at low signal level
- Built-in 12 multi-tone active interference canceller
- Free hybrid ephemeris prediction to achieve faster cold start
- Built-in data logger
- Built-in DC/DC converter to save power
- Allow direct connection with the lithium battery
- Up to 10 Hz update rate
- ±1ns high accuracy time pulse (1PPS)
- Capable of SBAS (WAAS, EGNOS, MSAS, GAGAN)

- Support Japan QZSS
- Indoor and outdoor multi-path detection and compensation
- RoHS compliant

3 Application

- Personal positioning and navigation
- Automotive navigation
- Marine navigation
- Weather balloon

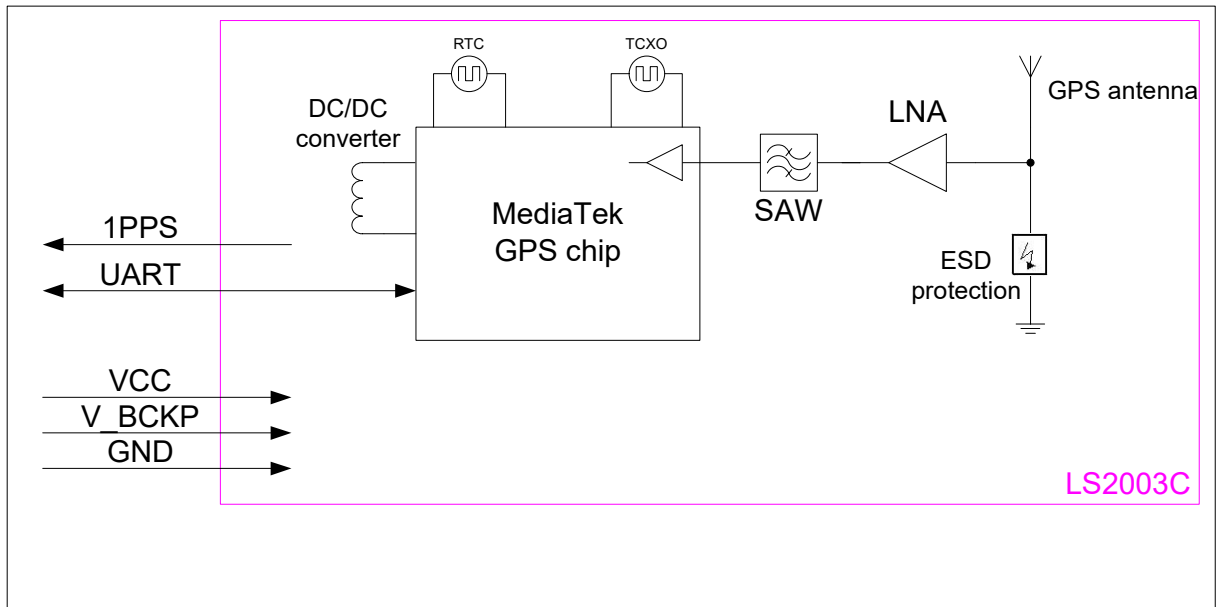

Fig 3-1 System block diagram of LS2003C

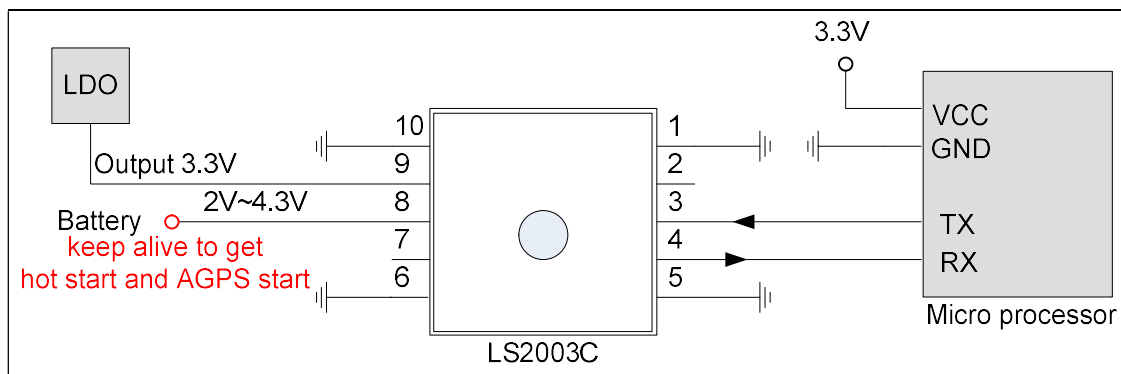

Fig 3-2 Typical application circuit

4 GPS receiver and antenna

4.1 GPS receiver

Chip	MediaTek MT3339	
Frequency	L1 1575.42MHz, C/A code	
Channels	Support 66 channels (22 Tracking, 66 Acquisition)	
Update rate	1Hz default, up to 10Hz	
Acquisition Time	Hot start (Open Sky)	< 1s (typical)
	Cold Start (Open Sky)	33s (typical) without AGPS
		< 15s (typical) with AGPS (hybrid ephemeris prediction)
Position Accuracy	Autonomous	2.5m CEP
	SBAS	2.5m (depends on accuracy of correction data)
Datum	WGS-84 (default)	
Max. Altitude	< 50,000 m	
Max. Velocity	< 515 m/s	
Protocol	NMEA 0183 ver 3.01	9600 bps ⁽¹⁾ , 8 data bits, no parity, 1 stop bits 1Hz: GGA, GLL, GSA, GSV, RMC, VTG

Note 1: Both baud rate and output message rate are configurable.

4.2 GPS antenna

Antenna type	Patch antenna (4mm thickness)
Polarization	RHCP
Frequency Range	1575.42MHz ± 1.023MHz ⁽¹⁾
Gain	2 dBic Typ. @zenith ⁽¹⁾
Axial ratio	Max 4.0dB @zenith ⁽¹⁾

Note 1: This value is measured with the evaluation board and must be fine tuned when installed into your device. Please contact LOCOSYS for your antenna tuning.

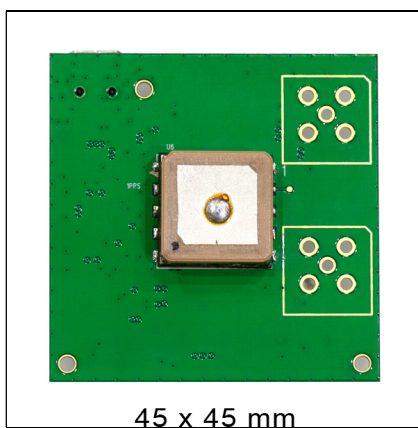

Fig 4-1 Evaluation board of LS2003C

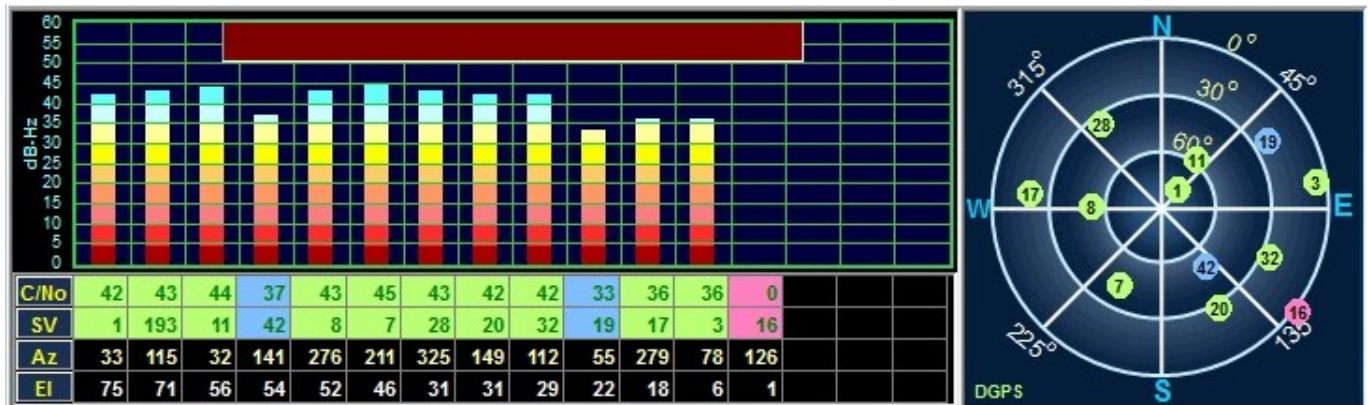

Fig 4-2 Receiving performance of LS2003C on the evaluation board in the open-sky field.

5 Software interface

5.1 NMEA output message

Table 5.1-1 NMEA output message

NMEA record	Description
GGA	Global positioning system fixed data
GLL	Geographic position - latitude/longitude
GSA	GPS DOP and active satellites
GSV	GPS satellites in view
RMC	Recommended minimum specific GPS data
VTG	Course over ground and ground speed

● GGA--- Global Positioning System Fixed Data

Table 5.1-2 contains the values for the following example:

\$GPGGA,053740.000,2503.6319,N,12136.0099,E,1,08,1.1,63.8,M,15.2,M,,0000*64

Table 5.1-2 GGA Data Format

Name	Example	Units	Description
Message ID	\$GPGGA		GGA protocol header
UTC Time	053740.000		hhmmss.sss
Latitude	2503.6319		ddmm.mmmm
N/S indicator	N		N=north or S=south
Longitude	12136.0099		dddmm.mmmm
E/W Indicator	E		E=east or W=west
Position Fix Indicator	1		See Table 5.1-3
Satellites Used	08		Range 0 to 12
HDOP	1.1		Horizontal Dilution of Precision
MSL Altitude	63.8	mters	

Units	M	mters	
Geoid Separation	15.2	mters	
Units	M	mters	
Age of Diff. Corr.		second	Null fields when DGPS is not used
Diff. Ref. Station ID	0000		
Checksum	*64		
<CR> <LF>			End of message termination

Table 5.1-3 Position Fix Indicators

Value	Description
0	Fix not available or invalid
1	GPS SPS Mode, fix valid
2	Differential GPS, SPS Mode, fix valid
3-5	Not supported
6	Dead Reckoning Mode, fix valid

● GLL--- Geographic Position – Latitude/Longitude

Table 5.1-4 contains the values for the following example:

\$GPGLL,2503.6319,N,12136.0099,E,053740.000,A,A*52

Table 5.1-4 GLL Data Format

Name	Example	Units	Description
Message ID	\$GPGLL		GLL protocol header
Latitude	2503.6319		ddmm.mmmm
N/S indicator	N		N=north or S=south
Longitude	12136.0099		dddmm.mmmm
E/W indicator	E		E=east or W=west
UTC Time	053740.000		hhmmss.sss
Status	A		A=data valid or V=data not valid
Mode	A		A=autonomous, D=DGPS, E=DR, N=Data not valid, R=Coarse Position, S=Simulator
Checksum	*52		
<CR> <LF>			End of message termination

● GSA---GNSS DOP and Active Satellites

Table 5.1-5 contains the values for the following example:

\$GPGSA,A,3,24,07,17,11,28,08,20,04,,,,,2.0,1.1,1.7*35

Table 5.1-5 GSA Data Format

Name	Example	Units	Description
Message ID	\$GPGSA		GSA protocol header
Mode 1	A		See Table 5.1-6
Mode 2	3		See Table 5.1-7
ID of satellite used	24		Sv on Channel 1
ID of satellite used	07		Sv on Channel 2
....		
ID of satellite used			Sv on Channel 12
PDOP	2.0		Position Dilution of Precision
HDOP	1.1		Horizontal Dilution of Precision
VDOP	1.7		Vertical Dilution of Precision
Checksum	*35		
<CR> <LF>			End of message termination

Table 5.1-6 Mode 1

Value	Description
M	Manual- forced to operate in 2D or 3D mode
A	Automatic-allowed to automatically switch 2D/3D

Table 5.1-7 Mode 2

Value	Description
1	Fix not available
2	2D
3	3D

● GSV---GNSS Satellites in View

Table 5.1-8 contains the values for the following example:

\$GPGSV,3,1,12,28,81,285,42,24,67,302,46,31,54,354,,20,51,077,46,*73

\$GPGSV,3,2,12,17,41,328,45,07,32,315,45,04,31,250,40,11,25,046,41*75

\$GPGSV,3,3,12,08,22,214,38,27,08,190,16,19,05,092,33,23,04,127,*7B

Table 5.1-8 GSV Data Format

Name	Example	Units	Description
Message ID	\$GPGSV		GSV protocol header
Total number of messages ¹	3		Range 1 to 3
Message number ¹	1		Range 1 to 3
Satellites in view	12		
Satellite ID	28		Channel 1 (Range 01 to 196)
Elevation	81	degrees	Channel 1 (Range 00 to 90)
Azimuth	285	degrees	Channel 1 (Range 000 to 359)

SNR (C/No)	42	dB-Hz	Channel 1 (Range 00 to 99, null when not tracking)
Satellite ID	20		Channel 4 (Range 01 to 196)
Elevation	51	degrees	Channel 4 (Range 00 to 90)
Azimuth	077	degrees	Channel 4 (Range 000 to 359)
SNR (C/No)	46	dB-Hz	Channel 4 (Range 00 to 99, null when not tracking)
Checksum	*73		
<CR> <LF>			End of message termination

1. Depending on the number of satellites tracked multiple messages of GSV data may be required.

● RMC---Recommended Minimum Specific GNSS Data

Table 5.1-9 contains the values for the following example:

\$GPRMC,053740.000,A,2503.6319,N,12136.0099,E,2.69,79.65,100106,,A*53

Table 5.1-9 RMC Data Format

Name	Example	Units	Description
Message ID	\$GPRMC		RMC protocol header
UTC Time	053740.000		hhmmss.sss
Status	A		A=data valid or V=data not valid
Latitude	2503.6319		ddmm.mmmm
N/S Indicator	N		N=north or S=south
Longitude	12136.0099		dddmm.mmmm
E/W Indicator	E		E=east or W=west
Speed over ground	2.69	knots	True
Course over ground	79.65	degrees	
Date	100106		ddmmyy
Magnetic variation		degrees	
Variation sense			E=east or W=west (Not shown)
Mode	A		A=autonomous, D=DGPS, E=DR, N=Data not valid, R=Coarse Position, S=Simulator
Checksum	*53		
<CR> <LF>			End of message termination

● VTG---Course Over Ground and Ground Speed

Table 5.1-10 contains the values for the following example:

\$GPVTG,79.65,T,,M,2.69,N,5.0,K,A*38

Table 5.1-10 VTG Data Format

Name	Example	Units	Description
Message ID	\$GPVTG		VTG protocol header

Course over ground	79.65	degrees	Measured heading
Reference	T		True
Course over ground		degrees	Measured heading
Reference	M		Magnetic
Speed over ground	2.69	knots	Measured speed
Units	N		Knots
Speed over ground	5.0	km/hr	Measured speed
Units	K		Kilometer per hour
Mode	A		A=autonomous, D=DGPS, E=DR, N=Data not valid, R=Coarse Position, S=Simulator
Checksum	*38		
<CR> <LF>			End of message termination

5.2 Proprietary NMEA input message

Please refer to MTK proprietary message.

5.3 Examples to configure the power mode of GPS module

5.3.1 Standby mode

User can issue software command to make GPS module go into standby mode that consumes less than 200uA current. GPS module will be awaked when receiving any byte. The following flow chart is an example to make GPS module go into standby mode and then wake up.

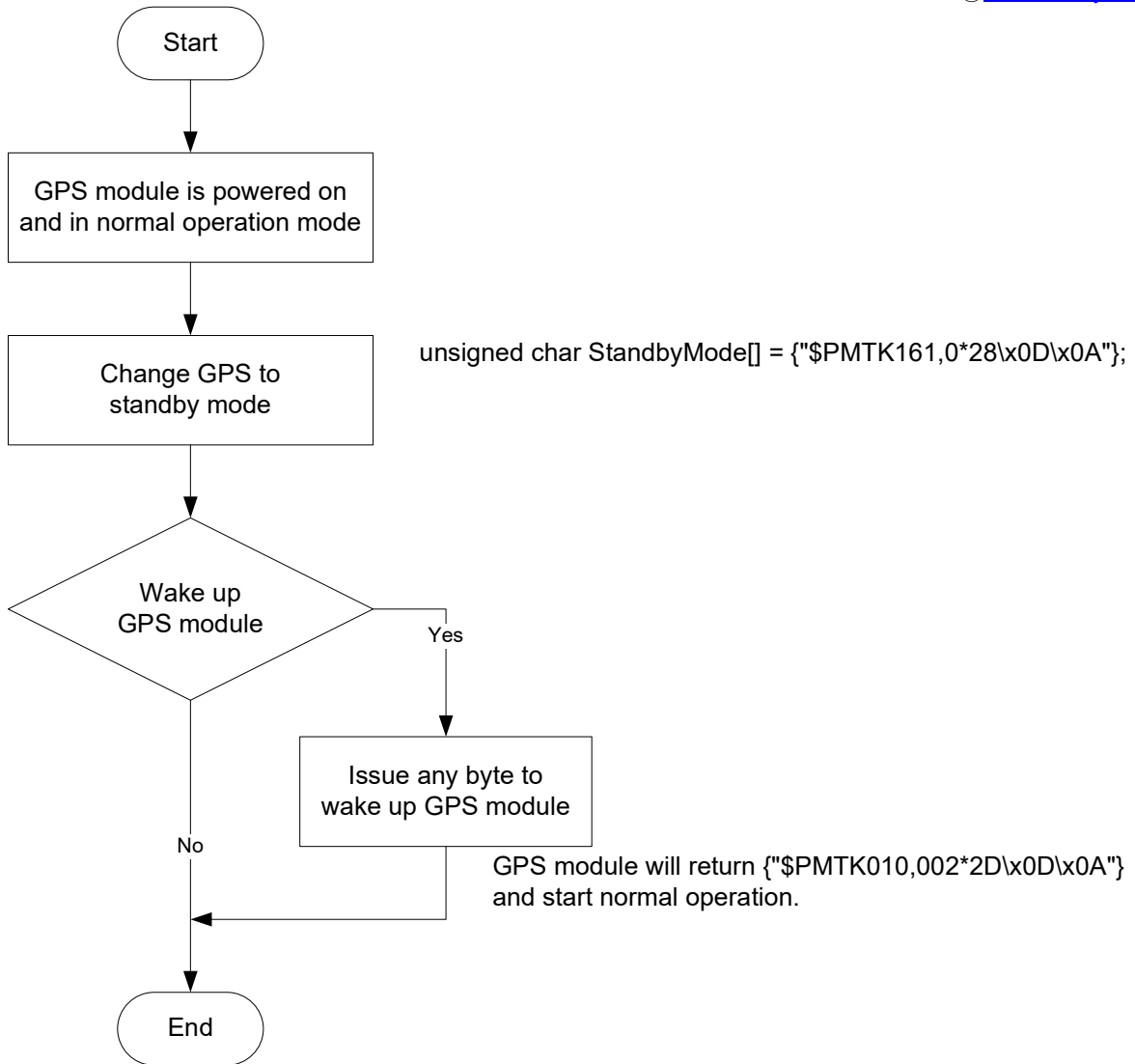

5.3.2 Periodic mode

When GPS module is commanded to periodic mode, it will be in operation and standby periodically. Its status of power consumption is as below chart.

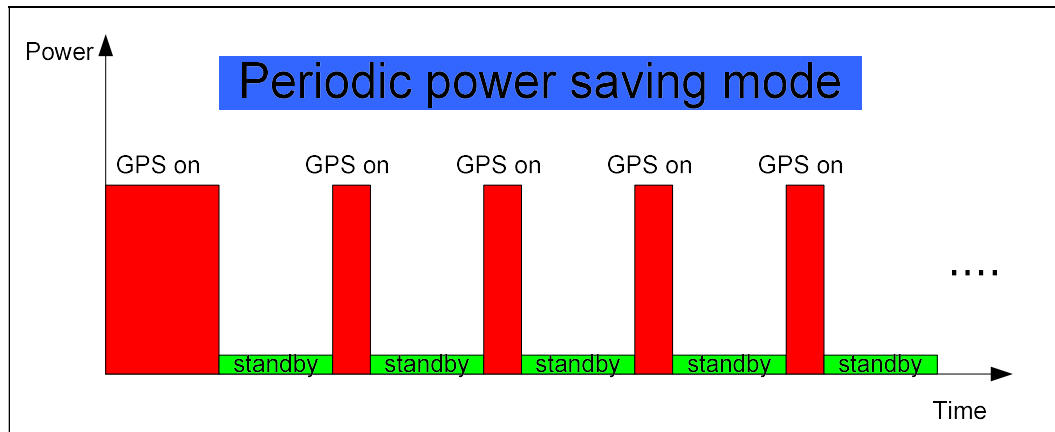

The following flow chart is an example to make GPS module go into periodic mode

and then back to normal operation mode.

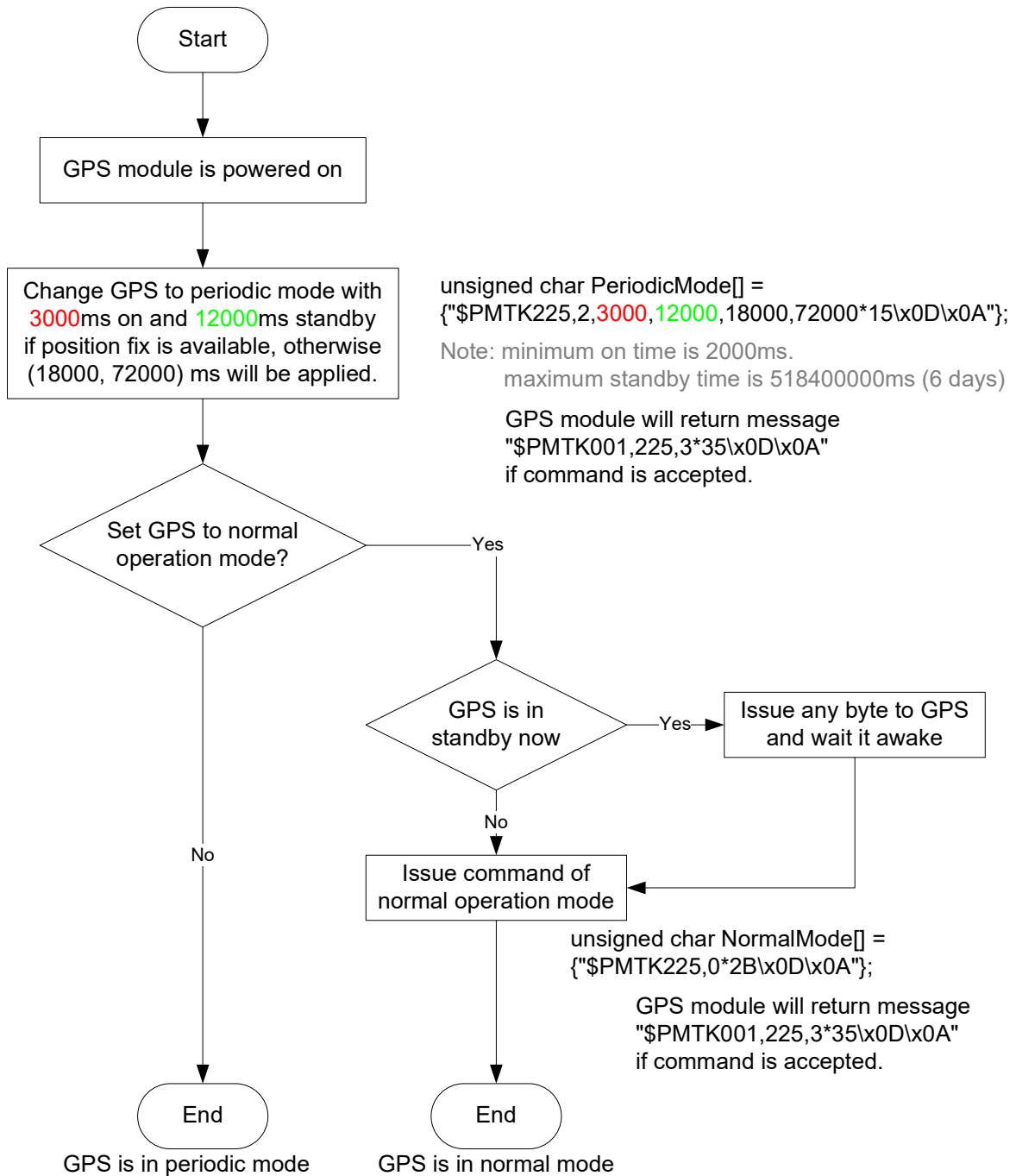

5.3.3 AlwaysLocate™ mode

AlwaysLocate™ is an intelligent controller of periodic mode. Depending on the environment and motion conditions, GPS module can adaptively adjust working/standby time to achieve balance of positioning accuracy and power consumption. In this mode, the host CPU does not need to control GPS module until the host CPU needs the GPS position data. The following flow chart is an example to make GPS module go into AlwaysLocate™ mode and then back to normal operation mode.

Note: AlwaysLocate™ is a trade mark of MTK.

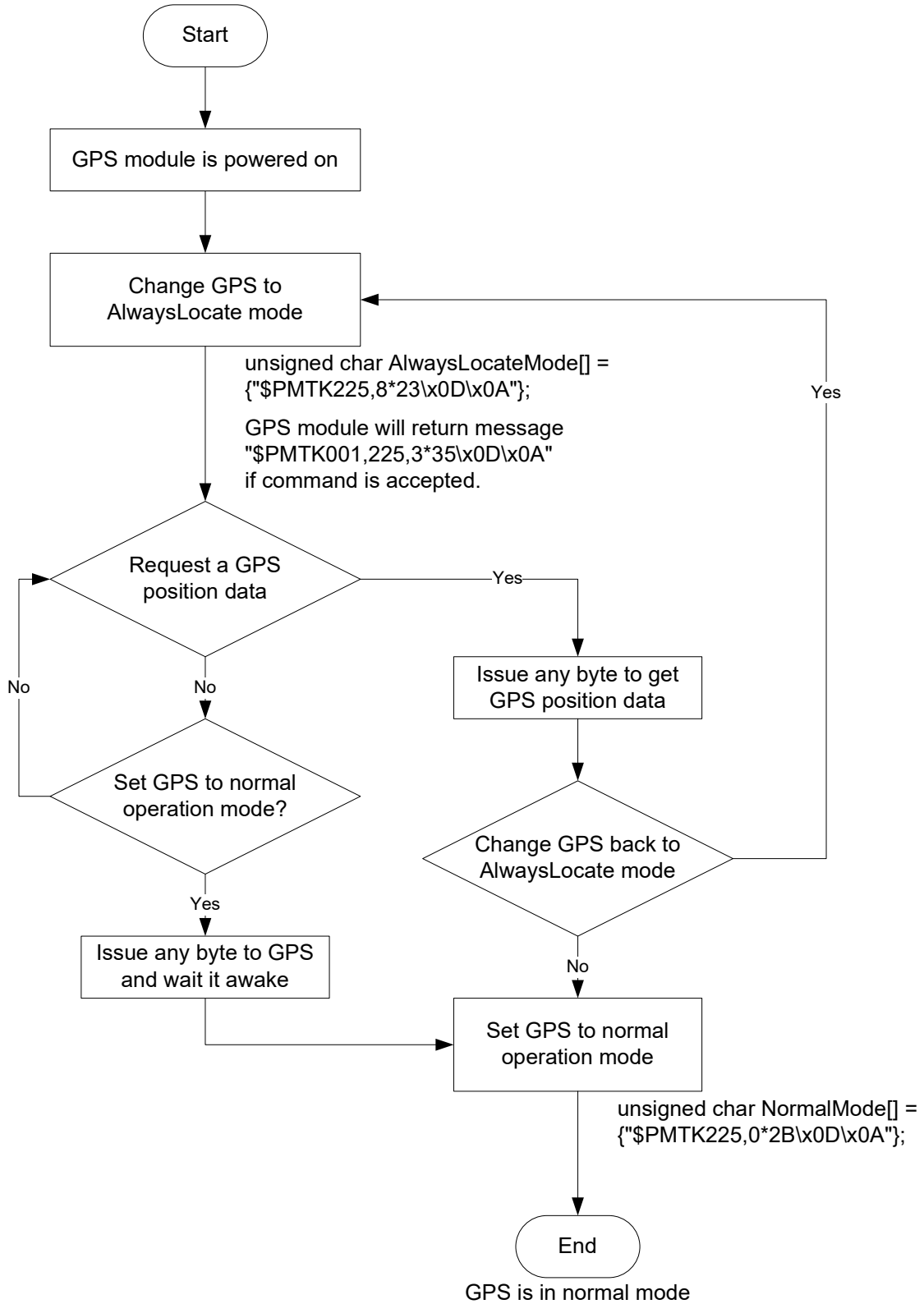

5.4 Data logger

The GPS module has internal flash memory for logging GPS data. The configurations

include time interval, distance, speed, logging mode, and ... etc. For more information, please contact us.

5.5 Examples to configure the update rate of GPS module

The GPS module supports up to 10Hz update rate that user can configure by issuing software commands. Note that the configurations by software commands are stored in the battery-backed SRAM that is powered through VBACKUP pin. Once it drains out, the default/factory settings will be applied.

Due to the transmitting capacity per second of the current baud rate, GPS module has to be changed to higher baud rate for high update rate of position fix. The user can use the following software commands to change baud rate.

Baud rate	Software command
Factory default	\$PMTK251,0*28<CR><LF>
4800	\$PMTK251,4800*14<CR><LF>
9600	\$PMTK251,9600*17<CR><LF>
19200	\$PMTK251,19200*22<CR><LF>
38400	\$PMTK251,38400*27<CR><LF>
57600	\$PMTK251,57600*2C<CR><LF>
115200	\$PMTK251,115200*1F<CR><LF>

Note: <CR> means Carriage Return, i.e. 0x0D in hexadecimal. <LF> means Line Feed, i.e. 0x0A in hexadecimal.

If the user does not want to change baud rate, you can reduce the output NMEA sentences by the following software commands.

NMEA sentence	Software command
Factory default	\$PMTK314,-1*04<CR><LF>
Only GLL at 1Hz	\$PMTK314,1,0,0,0,0,0,0,0,0,0,0,0,0,0,0*29<CR><LF>
Only RMC at 1Hz	\$PMTK314,0,1,0,0,0,0,0,0,0,0,0,0,0,0,0*29<CR><LF>
Only VTG at 1Hz	\$PMTK314,0,0,1,0,0,0,0,0,0,0,0,0,0,0,0*29<CR><LF>
Only GGA at 1Hz	\$PMTK314,0,0,0,1,0,0,0,0,0,0,0,0,0,0,0*29<CR><LF>
Only GSA at 1Hz	\$PMTK314,0,0,0,0,1,0,0,0,0,0,0,0,0,0,0*29<CR><LF>
Only GSV at 1Hz	\$PMTK314,0,0,0,0,0,1,0,0,0,0,0,0,0,0,0*29<CR><LF>
Only ZDA at 1Hz	\$PMTK314,0,0,0,0,0,0,0,0,0,0,0,0,0,0,1*29<CR><LF>
RMC, GGA, GSA at 1Hz and GSV at 0.2Hz	\$PMTK314,0,1,0,1,1,5,0,0,0,0,0,0,0,0,0*2C<CR><LF>
If the command is correct and executed, GPS module will output message	

```
$PMTK001,314,3*36<CR><LF>
```

After the GPS module is changed to higher baud rate or reduced NMEA sentence, the user can configure it to high update rate of position fix by the following commands.

Interval of position fix	Software command
Every 100ms (10Hz) ⁽¹⁾	\$PMTK220,100*2F<CR><LF>
Every 200ms (5Hz)	\$PMTK220,200*2C<CR><LF>
Every 500ms (2Hz)	\$PMTK220,500*2B<CR><LF>
Every 1000ms (1Hz)	\$PMTK220,1000*1F<CR><LF>
Every 2000ms (0.5Hz) ⁽²⁾	\$PMTK220,2000*1C<CR><LF>
If the command is correct and executed, GPS module will output message \$PMTK001,220,3*30<CR><LF>	

Note 1: The minimum interval of position fix is 100ms, i.e. the maximum update rate is 10Hz.

Note 2: The current consumption is the same with the update rate of 1Hz.

5.6 Configure the static navigation parameter

The output position of GPS module will keep the same and output speed will be zero if the actual speed is below the threshold of the static navigation parameter. This is useful for different applications. For example, the car stopped at a red light will get stationary GPS position if the threshold is 1.5m/s. It is better to disable this function by setting threshold to 0 for pedestrian navigation.

The format of the software command is as below.

```
$PMTK386,speed threshold*checksum<CR><LF>
```

The unit of speed threshold is meter per second. The range of speed threshold is from 0.1m/s to 2.0m/s. Value 0 is to disable the function.

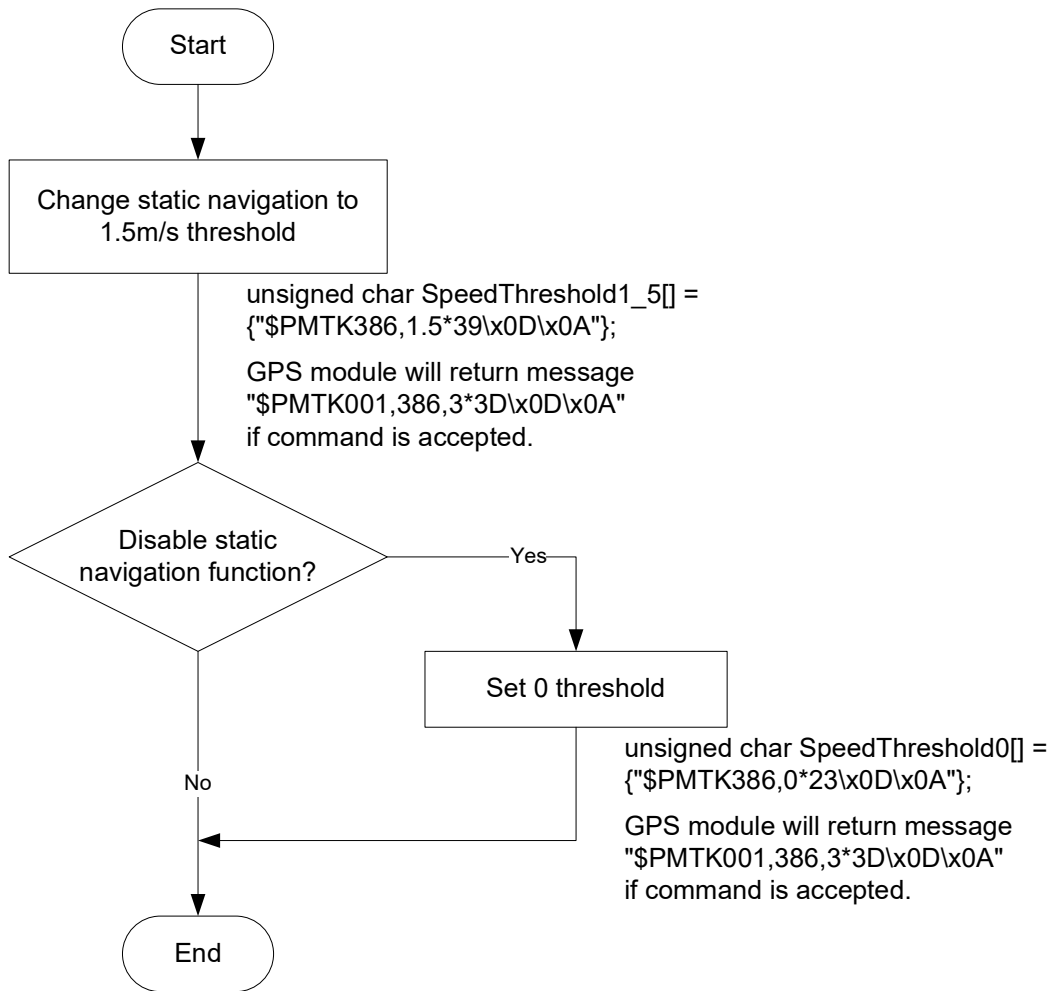

6 Pin assignment and descriptions

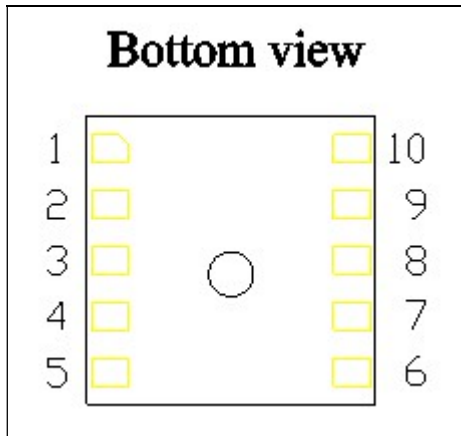

Pin #	Name	Type	Description
1	GND	P	Ground
2	1PPS	O	Pulse per second (default 100 ms pulse/sec when 3D fix is available)
3	RX	I	Serial data input
4	TX	O	Serial data output
5	GND	P	Ground
6	GND	P	Ground
7	NC		Not connect.
8	V_BCKP	P	Backup battery supply voltage. This pin must be powered to enable the module.
9	VCC	P	DC supply voltage
10	GND	P	Ground

7 DC & Temperature characteristics

7.1 Absolute maximum ratings

Parameter	Symbol	Ratings	Units
Input Voltage	VCC	4.3	V
Input Backup Battery Voltage	V_BCKP	4.3	V
Operating Temperature Range	Topr	-40 ~ 85	°C
Storage Temperature Range	Tstg	-40 ~ 85	°C

7.2 DC Electrical characteristics

Parameter	Symbol	Conditions	Min.	Typ.	Max.	Units
Input Voltage	VCC		3.0		4.3	V
Input Backup Battery Voltage	V_BCKP		2.0		4.3	V
Supply Current	I _{VCC}	Full operation		17 ⁽¹⁾	75 ⁽²⁾	mA
Backup Battery Current	I _{BAT}	VCC = 0		6		uA
High Level Input Voltage	V _{IH}		2.0		3.6	V
Low Level Input Voltage	V _{IL}		-0.3		0.8	V
High Level Input Current	I _{IH}		-1		1	uA
Low Level Input Current	I _{IL}		-1		1	uA
High Level Output Voltage	V _{OH}		2.4		3.3	V
Low Level Output Voltage	V _{OL}				0.4	V
High Level Output Current	I _{OH}			2		mA
Low Level Output Current	I _{OL}			2		mA

Note 1: Measured when position fix (1Hz) is available, input voltage is 3.3V and the function of self-generated ephemeris prediction is inactive. For different input voltage (VCC), the current consumption is as below chart. This is because LS2003C is built-in DC/DC converter.

Note 2: This happens when downloading AGPS data to LS2003C.

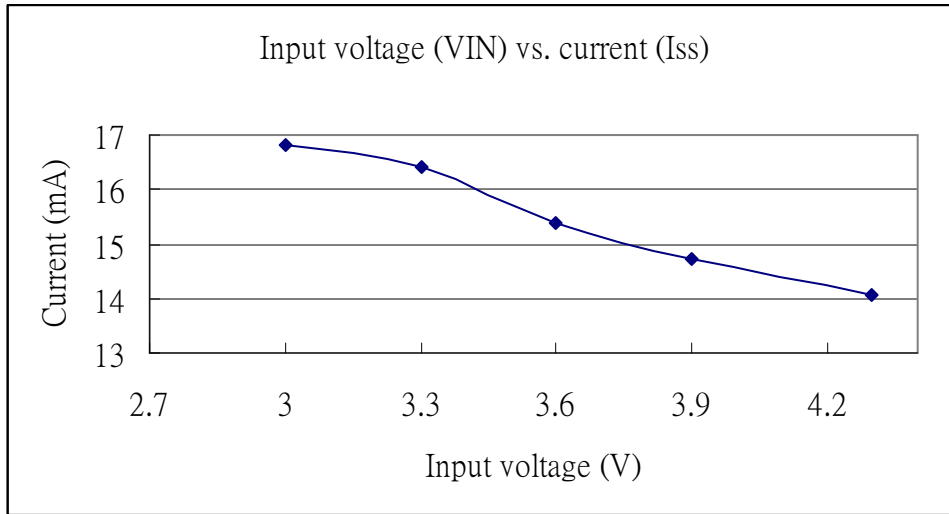

7.3 Temperature characteristics

Parameter	Symbol	Min.	Typ.	Max.	Units
Operating Temperature	Topr	-40	-	85	°C
Storage Temperature	Tstg	-40	25	85	°C

8 Mechanical specification
 8.1 Outline dimensions

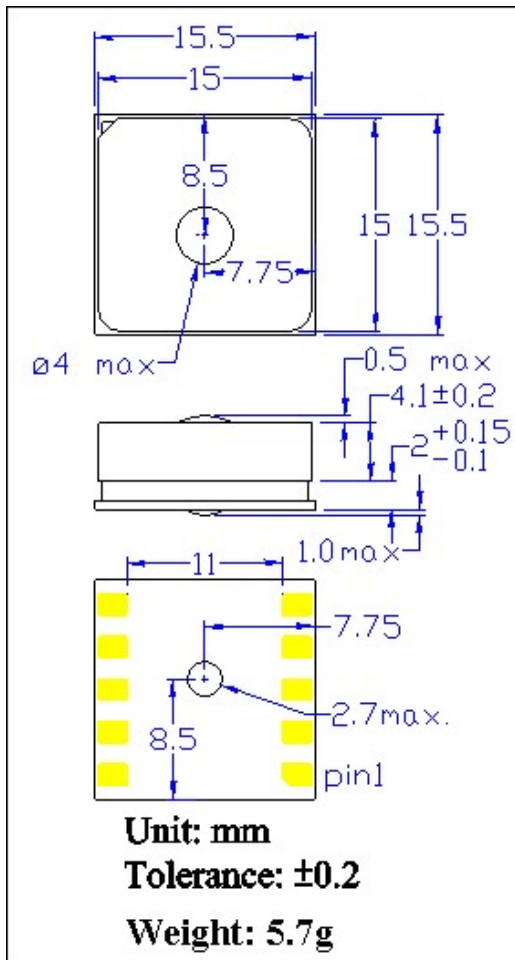

8.2 Recommended land pattern dimensions

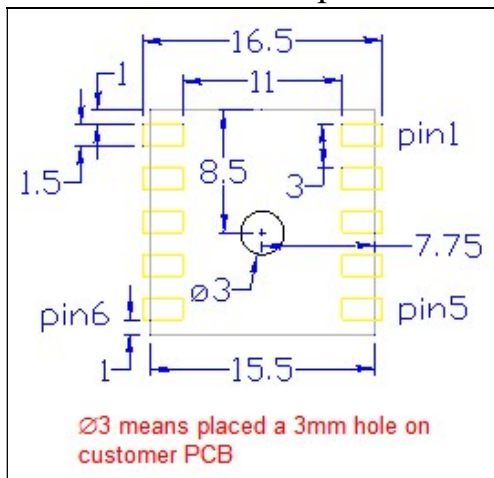

If double-sided SMT soldering is adopted and LS2003C is flipped over to pass through the reflow oven, heat curable SMD adhesives are strongly suggested between LS2003C and the PCB board to avoid LS2003C from falling off.

9 Packing information

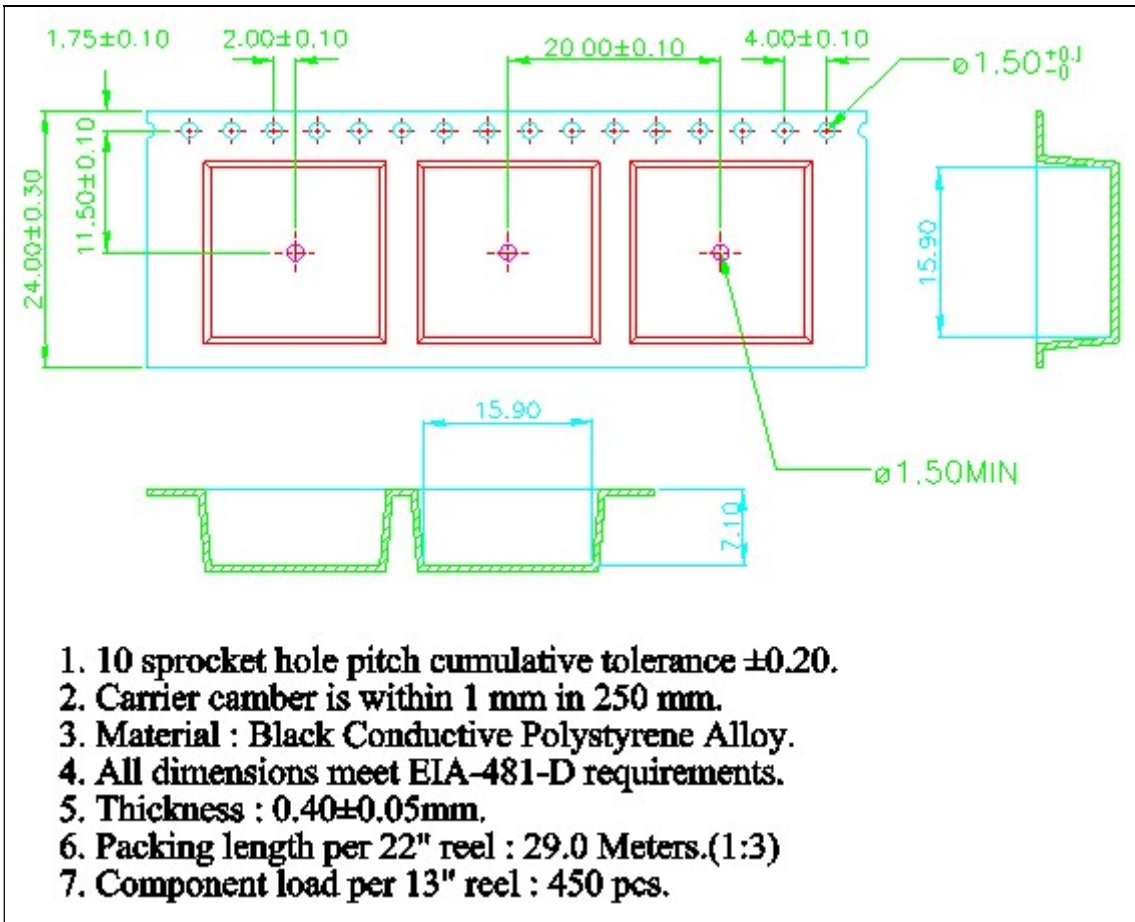

10 Packing and Handling

GPS modules, like any other SMD devices, are sensitive to moisture, electrostatic discharge, and temperature. By following the description sketched in the document for LOCOSYS GPS module storage and handling, it is possible to reduce the chances of them being damaged during production.

10.1 Packing

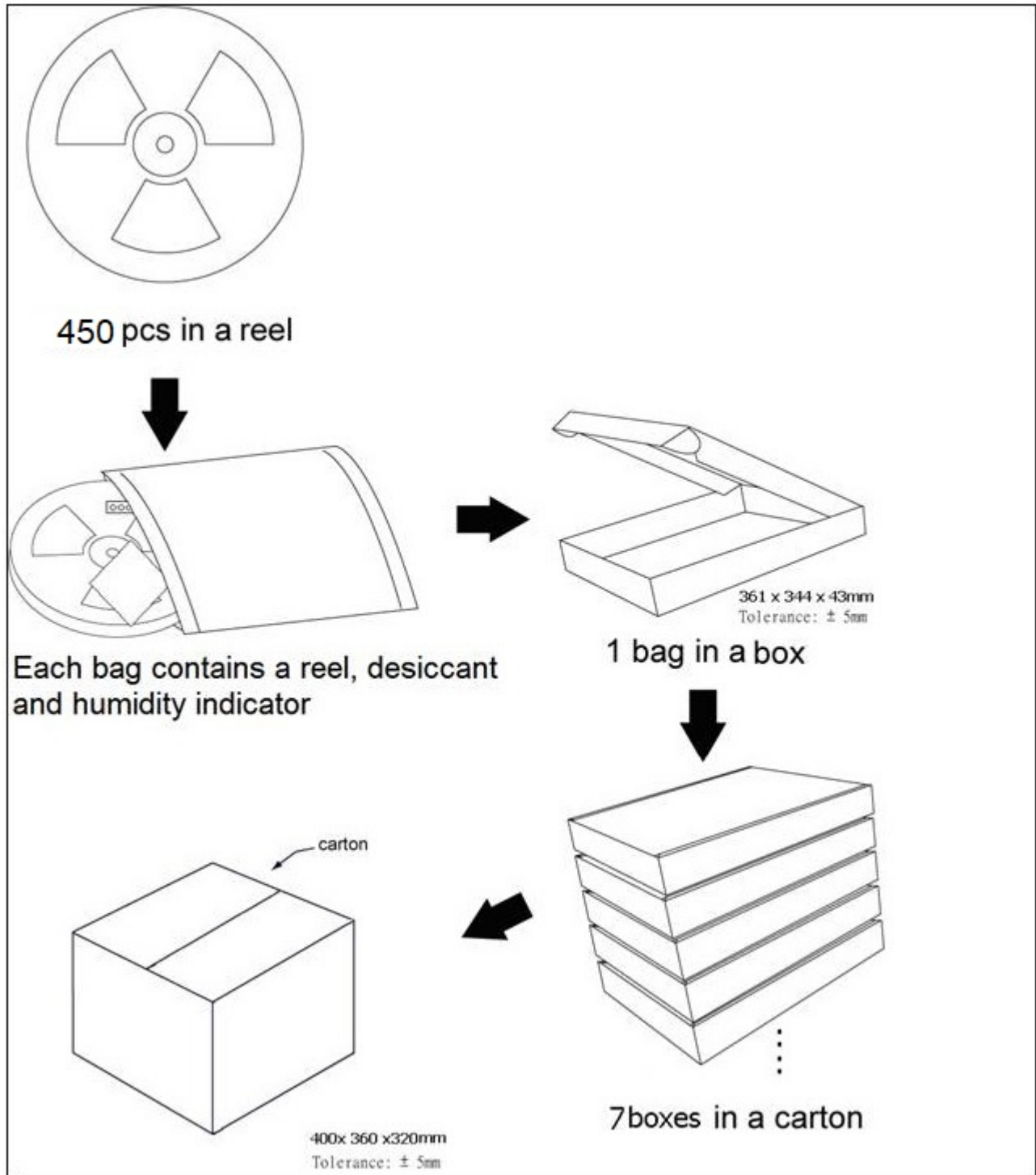

10.2 Moisture Sensitivity

The module belongs to moisture sensitive device (IPC/JEDEC J-STD-020C Level III). If it is not used by then, we strongly recommend storing the GPS modules in dry places such as dry cabinet. The approximate shelf life for LOCOSYS GPS modules packages is 6 months from the bag seal date, when store in a non-condensing storage environment (<30°C/60% RH)

10.3 ESD Handling



Please carefully follow the following precautions to prevent severe damage to GPS modules.

LOCOSYS GPS modules are sensitive to electrostatic discharges, and thus are Electrostatic Sensitive Devices (ESD). Careful handling of the GPS modules and in particular RF_IN pin must follow the standard ESD safety protections:

- Unless there is a galvanic coupling between the local (i.e. the worktable) GND and the PCB GND, then the first point of contact when handling the PCB shall always be between the local GND and PCB GND.
- Before working with RF_IN pin, please make sure the GND is connected.
- When working with RF_IN pin, do not contact any charges capacitors or materials that can easily develop or store charges such as patch antenna, coax cable, soldering iron.
- When soldering RF_IN pin, please make sure to use an ESD safe soldering iron (tip).

Document change list

Revision 1.0

- First release on January 9, 2013.

Revision 1.1 (August 20, 2013)

- Changed the pin protrusion length from 0.8 max to 1.0 max in the section 8.1.

Revision 1.2 (May 30, 2013)

- Added note for $\varnothing 3$ on the figure of section 8.2 recommended land pattern dimensions.

Revision 1.3 (Nov 25, 2020)

- Added Section 10 Packing and Handling.

Revision 1.4 (Nov 18, 2021)

- Revised autonomous position accuracy in section 4.